LOGICA

**Catalistino
2025**

INDICE VISIVO

LINEAR SYSTEM

	Linear System 6		Streamlight System 8		Streamlight accessori 9
	Streamlight Incasso 10				

MAGNETIC SYSTEM

	Klik Klak 11		Binario Klik Klak e accessori 18		Klik Klak Mini 20
	Binario Klik Klak Mini e accessori 26		Klik Klak Micro 28		Binario Klik Klak Micro e accessori 32



























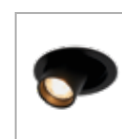

TRACK

	Fulgor 34		Bombo 40		Sun_111 42
	Unico Dicro 43		Unico AR111 43		Sospensioni Track 44-45
	Invisibile 45		Streamlight Track 46		Emergenza Track 51
	Tracks Tracks incasso + accessori 47-48				

DOWNLIGHTS

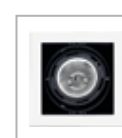
	Dot 52		Deep_EVO EXTR. 56-58-60		Deep_EVO LESS EXTR. 57-59-61
---	-----------	---	----------------------------	---	---------------------------------













DOWNLIGHTS

	Deep_EVO 62		Deep_EVO LESS 63		Deep_EVO GRANDE 64
	Deep_EVO LESS GRANDE 65		Deep_EVO_Q 66		Deep_EVO LESS_Q 66
	Deep_EVO_Q GRANDE 67		Deep_EVO STD 67		MODULI LED e Accessori 68-69
	Deep_EVO GU10 70		Deep_EVO AR111 GU10 71		Light_35 72
	Light_50 73		Light_111 75		Lumis_T 76
	Lumis_Q 76		Fulgor_IN 77		Bellatrix 78
	Punto Punto L 79-80		Occhio 81		Mini 82
	Zeus 85		Aqua_EVO COB 86		Aqua_EVO SMD 86
	Frame 88		Frame 111 89		Frameless 91
	Frameless 111 92		Wizard 94		

SUSPENSION LIGHTS

	A+B 95		Shanghai 96		Cyl Sosp 97
---	-----------	---	----------------	---	----------------

CEILING LIGHTS

	A+B 97		Fulgor 98		Sun_111 99
	Unico Dicro 100		Klik Klak puntiforme 101		Lumis_T 102
	Lumis_Q 102		Cyl 103		Altair 104-105
	Box Dicro 106		Box 111 106		Container 107
	Container 111 109				









WALL LIGHTS

	Torcia_V 110		Torcia_O 111		Minima 112
	Essential 113		Su&Giù 114		Bloc_Evo 114
	Dumbo 115		Sun_111 99		Fulgor 98
	Unico Dicro 100		Altair 104-105		

PROFILES

	Wall 116		Onda 117		Line_EVO 118
---	-------------	---	-------------	---	-----------------



PROFILES

	Line DEEP 120		Line 121		Line_MINI 122
	Double 123		PR1 124		PR1_DEEP 124
	PR2 125		PR2_DEEP 125		PR3_EVO 126

RECHARGEABLE

	Twiggy_LESS 127		Diogene 128		Iota 130
	Zen 131		Caricatore multiplo 127-131		Espositore Wireless 132

OUTDOOR

	Slice 133		Titano EVO 134		Moonlight 138
	Fos 140		Combi_Evo 141		Dardo 142
	Skorpio 143				

DRIVER E ACCESSORI

	Driver e Accessori 145
---	---------------------------

LINEAR SYSTEM DALI-PUSH



LED
CRI >90
PF 0,95

CODE	FINISHING	WATT	LUMEN	WATT LIGHT SOURCE	LUMEN LIGHT SOURCE	BEAM	KELVIN	MODE	KG	PRICE
42044	Bianco/white	32W	2270	28W	3320	70°	3000K	DALI-PUSH	3,50	197,50
42045	Bianco/white	32W	2280	28W	3370	70°	4000K	DALI-PUSH	3,50	197,50
42046	Nero/Black	32W	2270	28W	3320	70°	3000K	DALI-PUSH	3,50	197,50
42047	Nero/Black	32W	2280	28W	3370	70°	4000K	DALI-PUSH	3,50	197,50
42048	Bianco/white	47W	3320	42W	5000	70°	3000K	DALI-PUSH	4,90	266,00
42049	Bianco/white	47W	3390	42W	5500	70°	4000K	DALI-PUSH	4,90	266,00
42050	Nero/Black	47W	3320	42W	5000	70°	3000K	DALI-PUSH	4,90	266,00
42051	Nero/Black	47W	3390	42W	5500	70°	4000K	DALI-PUSH	4,90	266,00
42052	Bianco/white	64W	4470	57W	6772	70°	3000K	DALI-PUSH	6,20	333,00
42053	Bianco/white	64W	4530	57W	6800	70°	4000K	DALI-PUSH	6,20	333,00
42054	Nero/Black	64W	4470	57W	6772	70°	3000K	DALI-PUSH	6,20	333,00
42055	Nero/Black	64W	4530	57W	6800	70°	4000K	DALI-PUSH	6,20	333,00

INSTALLAZIONE APPLICATION

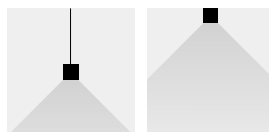

Sospensione/
Suspension

Soffitto/Ceiling

DISEGNI TECNICI TECHNICAL DRAWINGS

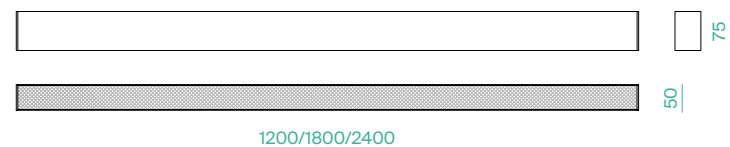

ACCESSORI ACCESSORIES



42056 - 42057

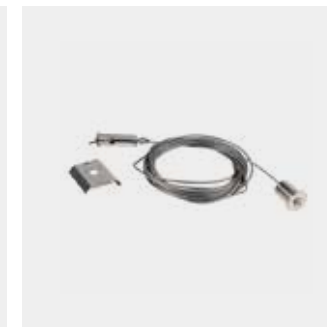

42058

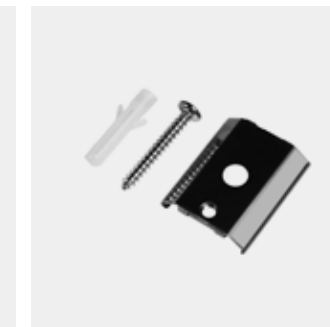

42059

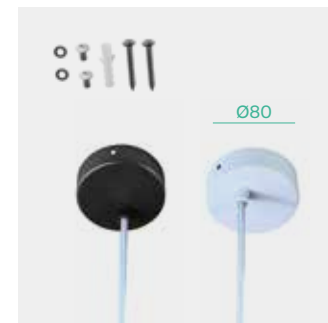

42060 - 42061

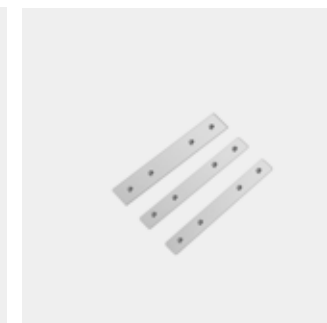

42062

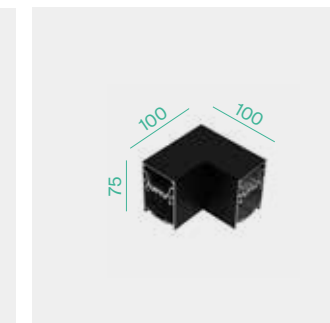

42064 - 42065

CODE	DESCRIPTION	FINISHING	PRICE
42056	Testate (2 pz.)/End-Caps (2 pc.)	Bianco/White	19,20
42057	Testate (2 pz.)/End-Caps (2 pc.)	Nero/Black	19,20
42058	Sospensione acciaio 2 mt (2 pz) / Steel cable 2 mt (2 pc.)	n/a	11,40
42059	Attacco a soffitto (2 pz.)/Ceiling bracket (2 pc.)	n/a	2,40
42060	Cavo elettrico e rosone ø80 mm 2 mt / Electric cable and canopy 80 mm 2 mt	Bianco/White	18,00
42061	Cavo elettrico e rosone ø80 mm 2 mt / Electric cable and canopy ø80 mm 2 mt	Nero/Black	18,00
42062	Congiunzione Lineare/Linear Connector	n/a	7,90
42064	Giunto "L"/"L"-Connector	Bianco/White	61,00
42065	Giunto "L"/"L"-Connector	Nero/Black	61,00



STREAMLIGHT SYSTEM

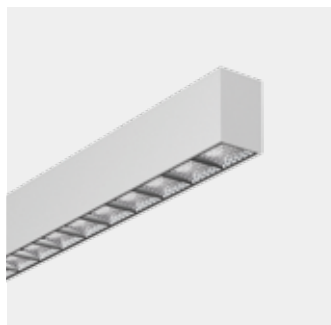

LED SAMSUNG
CRI >82
PF 0,9

CODE	FINISHING	WATT	LUMEN	WATT LIGHT SOURCE	LUMEN LIGHT SOURCE	BEAM	KELVIN	DRIVER	KG	PRICE
42654	Bianco/ White	27W+3W	2700 +300	22.5W+2.5W	3375+375	85°*85°	3000K	ON-OFF 36V-750mA	1,80	240,60
42655	Nero/Black	27W+3W	2700 +300	22.5W+2.5W	3375+375	85°*85°	3000K	ON-OFF 36V-750mA	1,80	240,60
42656	Bianco/ White	27W+3W	2800 +400	22.5W+2.5W	3600+400	85°*85°	4000K	ON-OFF 36V-750mA	1,80	240,60
42657	Nero/Black	27W+3W	2800 +400	22.5W+2.5W	3600+400	85°*85°	4000K	ON-OFF 36V-750mA	1,80	240,60
42662	Bianco/ White	41W+4W	4300 +400	34.2W+3.8W	5310+590	85°*85°	3000K	ON-OFF 36V-1250mA	3,50	390,32
42663	Nero/Black	41W+4W	4300 +400	34.2W+3.8W	5310+590	85°*85°	3000K	ON-OFF 36V-1250mA	3,50	390,32
42664	Bianco/ White	41W+4W	4500 +500	34.2W+3.8W	5625+625	85°*85°	4000K	ON-OFF 36V-1250mA	3,50	390,32
42665	Nero/Black	41W+4W	4500 +500	34.2W+3.8W	5625+625	85°*85°	4000K	ON-OFF 36V-1250mA	3,50	390,32
42776	Bianco/ White	27W+3W	2700 +300	22.5W+2.5W	3375+375	85°*85°	3000K	1-10V 36V-750mA	1,80	291,63
42777	Nero/Black	27W+3W	2700 +300	22.5W+2.5W	3375+375	85°*85°	3000K	1-10V 36V-750mA	1,80	291,63
42778	Bianco/ White	27W+3W	2800 +400	22.5W+2.5W	3600+400	85°*85°	4000K	1-10V 36V-750mA	1,80	291,63
42779	Nero/Black	27W+3W	2800 +400	22.5W+2.5W	3600+400	85°*85°	4000K	1-10V 36V-750mA	1,80	291,63
42780	Bianco/ White	41W+4W	4300 +400	34.2W+3.8W	5310+590	85°*85°	3000K	1-10V 36V-1250mA	3,50	437,47
42781	Nero/Black	41W+4W	4300 +400	34.2W+3.8W	5310+590	85°*85°	3000K	1-10V 36V-1250mA	3,50	437,47
42782	Bianco/ White	41W+4W	4500 +500	34.2W+3.8W	5625+625	85°*85°	4000K	1-10V 36V-1250mA	3,50	437,47
42783	Nero/Black	41W+4W	4500 +500	34.2W+3.8W	5625+625	85°*85°	4000K	1-10V 36V-1250mA	3,50	437,47
42658	Bianco/ White	27W+3W	2700 +300	22.5W+2.5W	3375+375	85°*85°	3000K	DALI-PUSH 36V-750mA	1,80	331,74
42659	Nero/Black	27W+3W	2700 +300	22.5W+2.5W	3375+375	85°*85°	3000K	DALI-PUSH 36V-750mA	1,80	331,74
42660	Bianco/ White	27W+3W	2800 +400	22.5W+2.5W	3600+400	85°*85°	4000K	DALI-PUSH 36V-750mA	1,80	331,74
42661	Nero/Black	27W+3W	2800 +400	22.5W+2.5W	3600+400	85°*85°	4000K	DALI-PUSH 36V-750mA	1,80	331,74
42666	Bianco/ White	41W+4W	4300 +400	34.2W+3.8W	5310+590	85°*85°	3000K	DALI-PUSH 36V-1250mA	3,50	487,53
42667	Nero/Black	41W+4W	4300 +400	34.2W+3.8W	5310+590	85°*85°	3000K	DALI-PUSH 36V-1250mA	3,50	487,53
42668	Bianco/ White	41W+4W	4500 +500	34.2W+3.8W	5625+625	85°*85°	4000K	DALI-PUSH 36V-1250mA	3,50	487,53
42669	Nero/Black	41W+4W	4500 +500	34.2W+3.8W	5625+625	85°*85°	4000K	DALI-PUSH 36V-1250mA	3,50	487,53

INSTALLAZIONE APPLICATION



Sospensione/ Suspension Soffitto/Ceiling

DISEGNI TECNICI TECHNICAL DRAWINGS

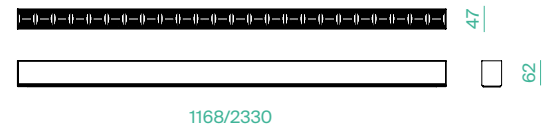

ACCESSORI ACCESSORIES



42672



42673 - 42674



42677 - 42678



42675 - 42676

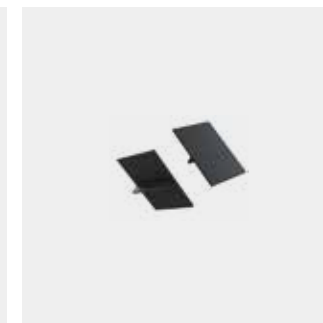

42679 - 42680

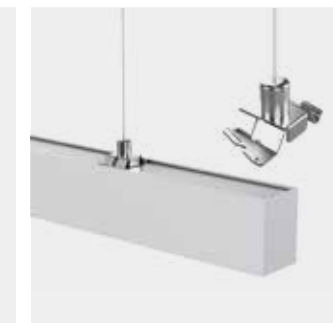

42681 - 42682 - 42685

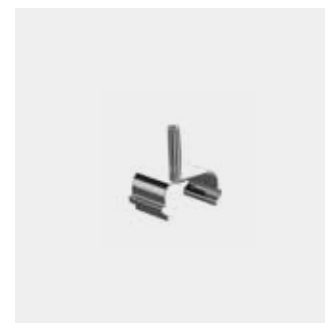

42728

CODE	DESCRIPTION	FINISHING	PRICE
42672	Congiunzione Lineare/Linear Connector	Alluminio/Aluminium	7,29
42673	Giunto "L"/"L"-Connector	Nero / Black	13,13
42674	Giunto "L"/"L"-Connector	Bianco / White	13,13
42675	Giunto "X"/"X"-Connector	Nero / Black	18,22
42676	Giunto "X"/"X"-Connector	Bianco / White	18,22
42677	Giunto "T"/"T"-Connector	Nero / Black	16,04
42678	Giunto "T"/"T"-Connector	Bianco / White	16,04
42679	Testate (2 Pcs.)/End-Caps	Nero / Black	5,84
42680	Testate (2 Pcs.)/End-Caps	Bianco / White	5,84
42681	Sospensione acciaio 2 mt (1 pz) / Steel cable 2 mt (1 pc)	n/a	9,96
42682	Sospensione e rosone ø115mm 2 mt (1 pz) / Suspension and canopy ø115mm 2 mt (1 pc)	Nero/Black	17,25
42685	Sospensione e rosone ø115mm 2 mt (1 pz) / Suspension and canopy ø115mm 2 mt (1 pc)	Bianco / White	17,25
42728	Attacco a soffitto/Ceiling bracket	n/a	5,84

STREAMLIGHT INCASSO



LED SAMSUNG
CRI >82
PF 0,9

CODE	FINISHING	WATT	LUMEN	BEAM	KELVIN	KG	PRICE
42730	Bianco/White	24W	2200	85°*85°	3000K	0,40	48,13
42731	Bianco/White	24W	2400	85°*85°	4000K	0,40	48,13

INSTALLAZIONE APPLICATION

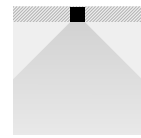

Incasso/Recessed

DISEGNI TECNICI TECHNICAL DRAWINGS

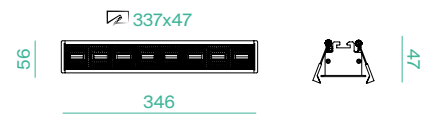

DRIVER

CODE	VOLT	CURRENT	PF	SIZE	MODE	PRICE
42732	24-42V	650mA	0,9	120x45x30	ON-OFF	26,74

KLIK KLAK PROIETTORE

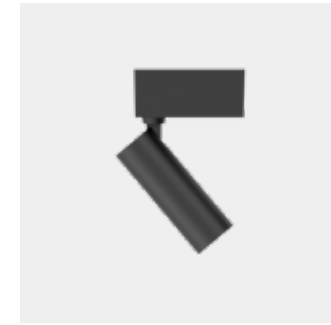

LED CREE
CRI >90
PF >0,7
SDCM <3

CODE	FINISHING	WATT	LUMEN	WATT LIGHT SOURCE	LUMEN LIGHT SOURCE	BEAM	KELVIN	KG	PRICE
41111	Nero/Black	10W	749	8W	900	36°	3000K	0,35	93,58
41112	Bianco/White	10W	749	8W	900	36°	3000K	0,35	93,58
41179	Nero/Black	10W	870	8W	1100	36°	4000K	0,35	93,58
41192	Bianco/White	10W	870	8W	1100	36°	4000K	0,35	93,58
41772	Nero/Black	20W	1450	16W	1870	36°	3000K	0,78	139,51
41773	Bianco/White	20W	1450	16W	1870	36°	3000K	0,78	139,51

INSTALLAZIONE APPLICATION



Binario magnetico/
Magnetic track

DISEGNI TECNICI TECHNICAL DRAWINGS

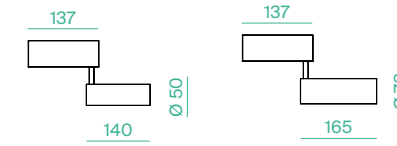

41111 41179 41772
41112 41192 41773

REGOLAZIONI ADJUSTABILITY



KLIK KLAK PROIETTORE

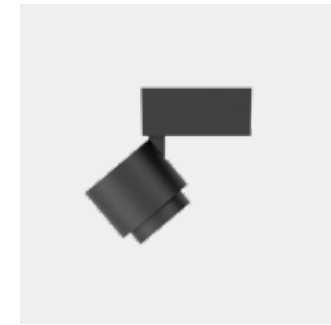

LED CREE
CRI >90
PF >0,7
SDCM <3

CODE	FINISHING	WATT	LUMEN	WATT LIGHT SOURCE	LUMEN LIGHT SOURCE	BEAM	KELVIN	KG	PRICE
41176	Nero/Black	8W	404	6W	755	36°	3000K	0,42	99,65
41175	Bianco/White	8W	404	6W	755	36°	3000K	0,42	99,65
41178	Nero/Black	15W	904	12W	1395	36°	3000K	0,57	132,45
41177	Bianco/White	15W	904	12W	1395	36°	3000K	0,57	132,45
41214	Nero/Black	8W	483	6W	816	36°	4000K	0,42	99,65
41213	Bianco/White	8W	483	6W	816	36°	4000K	0,42	99,65
41216	Nero/Black	15W	957	12W	1477	36°	4000K	0,57	132,45
41215	Bianco/White	15W	957	12W	1477	36°	4000K	0,57	132,45

INSTALLAZIONE APPLICATION

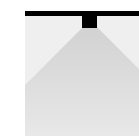

Binario magnetico/
Magnetic track

DISEGNI TECNICI TECHNICAL DRAWINGS

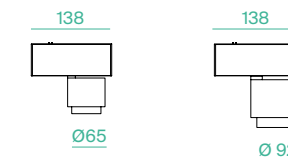

41175 41213 41177 41215
41176 41214 41178 41216

REGOLAZIONI ADJUSTABILITY



LOGICA

KLIK KLAK PROIETTORE Q

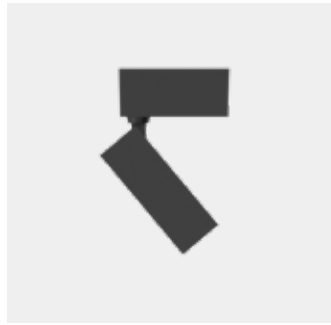

LED CREE
CRI >90
PF >0,5
SDCM <3

CODE	FINISHING	WATT	LUMEN	WATT LIGHT SOURCE	LUMEN LIGHT SOURCE	BEAM	KELVIN	KG	PRICE
41770	Nero/Black	10W	749	8W	900	36°	3000K	0,52	99,50
41771	Bianco/White	10W	749	8W	900	36°	3000K	0,52	99,50

INSTALLAZIONE APPLICATION

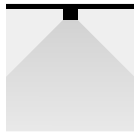

Binario magnetico/
Magnetic track

DISEGNI TECNICI TECHNICAL DRAWINGS

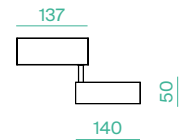

REGOLAZIONI ADJUSTABILITY



KLIC KLAK GLOBO

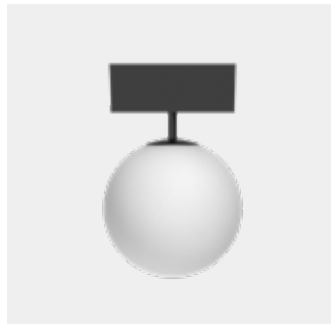

LED CREE
CRI >90
PF >0,5
SDCM <3

CODE	FINISHING	WATT	LUMEN	WATT LIGHT SOURCE	LUMEN LIGHT SOURCE	BEAM	KELVIN	KG	PRICE
41778	Nero/Black	10W	680	8W	1105	DIFF.	3000K	0,46	88,68
41779	Bianco/White	10W	680	8W	1105	DIFF.	3000K	0,46	88,68

INSTALLAZIONE APPLICATION

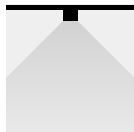

Binario magnetico/
Magnetic track

DISEGNI TECNICI TECHNICAL DRAWINGS

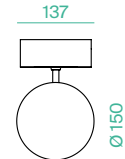

KLIC KLAK PUNTIFORME

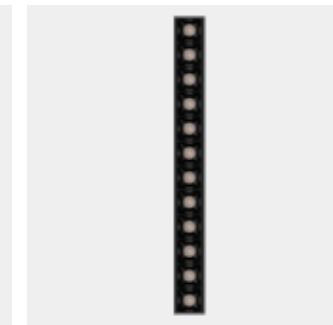
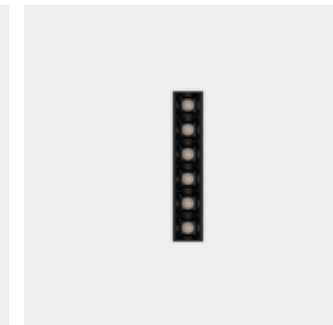
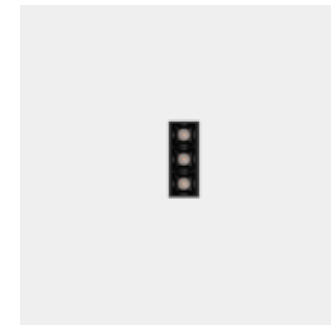

LED CREE
CRI >90
PF >0,7
SDCM <3

CODE	FINISHING	WATT	LUMEN	WATT LIGHT SOURCE	LUMEN LIGHT SOURCE	BEAM	KELVIN	KG	PRICE
41119	Nero/Black	4W	375	3W	429	34°	3000K	0,16	48,61
41122	Bianco/White	4W	375	3W	429	34°	3000K	0,16	48,61
41120	Nero/Black	8W	788	6W	819	34°	3000K	0,28	68,05
41123	Bianco/White	8W	788	6W	819	34°	3000K	0,28	68,05
41121	Nero/Black	16W	1519	12W	1647	34°	3000K	0,40	120,30
41124	Bianco/White	16W	1519	12W	1647	34°	3000K	0,40	120,30
41199	Nero/Black	4W	381	3W	438	34°	4000K	0,16	48,61
41202	Bianco/White	4W	381	3W	438	34°	4000K	0,16	48,61
41200	Nero/Black	8W	741	6W	832	34°	4000K	0,28	68,05
41203	Bianco/White	8W	741	6W	832	34°	4000K	0,28	68,05
41201	Nero/Black	16W	1530	12W	1729	34°	4000K	0,40	120,30
41204	Bianco/White	16W	1530	12W	1729	34°	4000K	0,40	120,30

INSTALLAZIONE APPLICATION

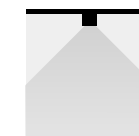

Binario magnetico/
Magnetic track

DISEGNI TECNICI TECHNICAL DRAWINGS

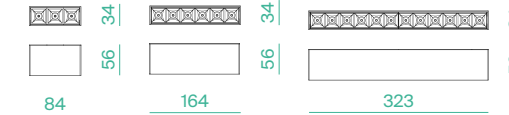

41199 41200 41201
41202 41203 41204
41119 41120 41121
41122 41123 41124



KLIK_KLAK PUNIFORME ORIENTABILE



LED CREE
CRI >90
PF >0,7
SDCM <3

CODE	FINISHING	WATT	LUMEN	WATT LIGHT SOURCE	LUMEN LIGHT SOURCE	BEAM	KELVIN	KG	PRICE
41125	Nero/Black	4W	375	3W	429	34°	3000K	0,49	120,30
41128	Bianco/White	4W	375	3W	429	34°	3000K	0,49	120,30
41126	Nero/Black	8W	788	6W	819	34°	3000K	0,88	156,76
41129	Bianco/White	8W	788	6W	819	34°	3000K	0,88	156,76
41127	Nero/Black	16W	1519	12W	1647	34°	3000K	1,30	241,82
41130	Bianco/White	16W	1519	12W	1647	34°	3000K	1,30	241,82
41205	Nero/Black	4W	381	3W	438	34°	4000K	0,49	120,30
41208	Bianco/White	4W	381	3W	438	34°	4000K	0,49	120,30
41206	Nero/Black	8W	741	6W	832	34°	4000K	0,88	156,76
41209	Bianco/White	8W	741	6W	832	34°	4000K	0,88	156,76
41207	Nero/Black	16W	1530	12W	1729	34°	4000K	1,30	241,82
41210	Bianco/White	16W	1530	12W	1729	34°	4000K	1,30	241,82

INSTALLAZIONE APPLICATION

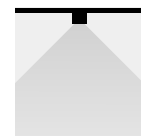

Binario magnetico/
Magnetic track

DISEGNI TECNICI TECHNICAL DRAWINGS

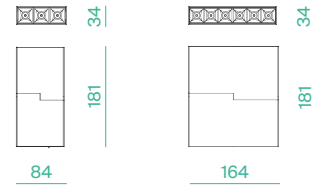

41205 41206
41208 41209
41125 41126
41128 41129

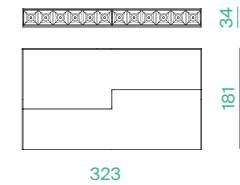

41207
41210
41127
41130

REGOLAZIONI ADJUSTABILITY



KLIK_KLAK LUCÈ DIFFUSA

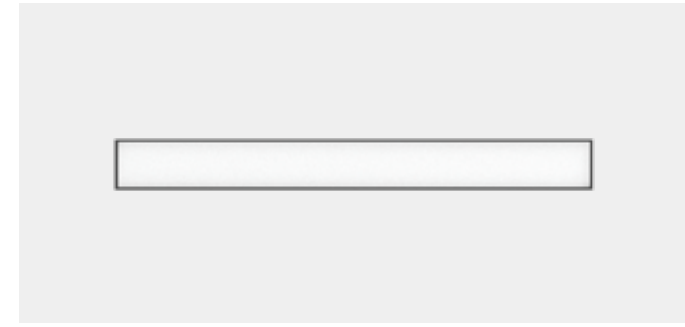

LED CREE
CRI >90
PF >0,7
SDCM <3

CODE	FINISHING	WATT	LUMEN	WATT LIGHT SOURCE	LUMEN LIGHT SOURCE	BEAM	KELVIN	KG	PRICE
41113	Nero/Black	13W	962	10W	1560	105°	3000K	0,48	96,00
41116	Bianco/White	13W	962	10W	1560	105°	3000K	0,48	96,00
41114	Nero/Black	26W	1858	20W	3052	105°	3000K	0,96	168,91
41117	Bianco/White	26W	1858	20W	3052	105°	3000K	0,96	168,91
41115	Nero/Black	39W	2729	30W	4368	105°	3000K	1,44	241,82
41118	Bianco/White	39W	2729	30W	4368	105°	3000K	1,44	241,82
41193	Nero/Black	13W	965	10W	1638	105°	4000K	0,48	96,00
41196	Bianco/White	13W	965	10W	1638	105°	4000K	0,48	96,00
41194	Nero/Black	26W	2030	20W	3113	105°	4000K	0,96	168,91
41197	Bianco/White	26W	2030	20W	3113	105°	4000K	0,96	168,91
41195	Nero/Black	39W	2945	30W	4543	105°	4000K	1,44	241,82
41198	Bianco/White	39W	2945	30W	4543	105°	4000K	1,44	241,82

INSTALLAZIONE APPLICATION

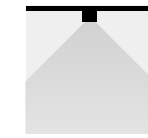

Binario magnetico/
Magnetic track

DISEGNI TECNICI TECHNICAL DRAWINGS



41113 41193
41116 41196

41114 41194
41117 41197



41115 41195
41118 41198



KLIK_KLAK SOSPENSIONE



LED CREE
CRI >90
PF >0,5
SDCM <3

CODE	FINISHING	WATT	LUMEN	WATT LIGHT SOURCE	LUMEN LIGHT SOURCE	BEAM	KELVIN	KG	PRICE
41174	Nero/Black	10W	749	8W	900	36°	3000K	0,56	108,15
41173	Bianco/White	10W	749	8W	900	36°	3000K	0,56	108,15
41212	Nero/Black	10W	870	8W	1100	36°	4000K	0,56	108,15
41211	Bianco/White	10W	870	8W	1100	36°	4000K	0,56	108,15

INSTALLAZIONE
APPLICATION

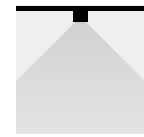

Binario magnetico/
Magnetic track

DISEGNI TECNICI
TECHNICAL DRAWINGS

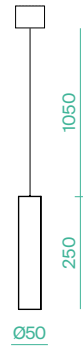

KLIK_KLAK SOSPENSIONE BELL



LED CREE
CRI >90
PF >0,5
SDCM <3

CODE	FINISHING	WATT	LUMEN	WATT LIGHT SOURCE	LUMEN LIGHT SOURCE	BEAM	KELVIN	KG	PRICE
41776	Nero/Black	10W	415,8	8W	900	65°	3000K	0,44	89,76
41777	Bianco/White	10W	571,9	8W	900	65°	3000K	0,44	89,76

INSTALLAZIONE
APPLICATION

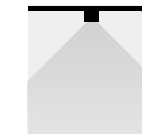

Binario magnetico/
Magnetic track

DISEGNI TECNICI
TECHNICAL DRAWINGS

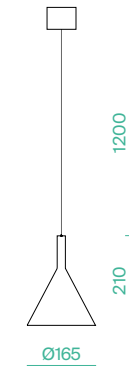

KLIK_KLAK SOSPENSIONE GLOBO



LED CREE
CRI >90
PF 0,5
SDCM <3

CODE	FINISHING	WATT	LUMEN	WATT LIGHT SOURCE	LUMEN LIGHT SOURCE	BEAM	KELVIN	KG	PRICE
41774	Nero/Black	10W	680	8W	1105	DIFF.	3000K	0,50	93,01
41775	Bianco/White	10W	680	8W	1105	DIFF.	3000K	0,50	93,01

INSTALLAZIONE
APPLICATION

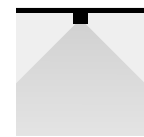

Binario magnetico/
Magnetic track

DISEGNI TECNICI
TECHNICAL DRAWINGS

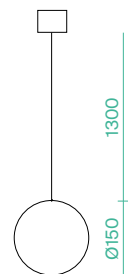

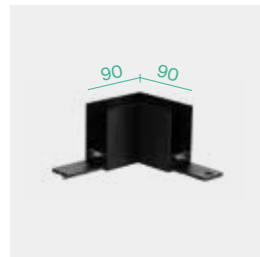

41136 - 41137



41138 - 41139



41140 - 41141

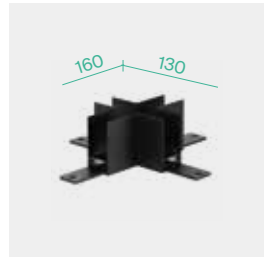

41257 - 41258

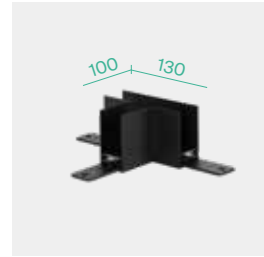

41259 - 41260



41142 - 41143

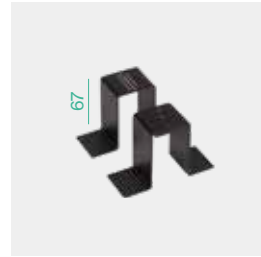

41131



41222 - 41223



41132/A - 41133/A



41134 - 41135



41240 - 41241



42787 - 42784 - 42788 - 42785



42789 - 42786



42811 - 42808 - 42812 - 42809



42813 - 42810

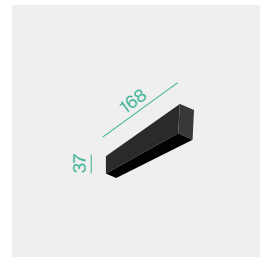

41782 - 41783

CODE	FINISHING	DESCRIPTION	KG	PRICE
41109	Nero / Black	Struttura 1mt in alluminio estruso con testate / 1mt extruded aluminium profile with end-caps	1,50	108,15
41110	Bianco / White	Struttura 1mt in alluminio estruso con testate / 1mt extruded aluminium profile with end-caps	1,50	108,15
41144	Nero / Black	Struttura 2mt in alluminio estruso con testate / 2mt extruded aluminium profile with end-caps	3,00	216,30
41145	Bianco / White	Struttura 2mt in alluminio estruso con testate / 2mt extruded aluminium profile with end-caps	3,00	216,30
41146	Nero / Black	Copertura per rasatura 1 mt / 1 mt mask for plasterboard thinning	6,68	
41136	Nero / Black	Angolo 90° e accessori / 90° corner with accessories	53,47	
41137	Bianco / White	Angolo 90° e accessori / 90° corner with accessories	53,47	
41138	Nero / Black	Angolo 90° esterno e accessori / Outer 90° corner with accessories	53,47	
41139	Bianco / White	Angolo 90° esterno e accessori / Outer 90° corner with accessories	53,47	
41140	Nero / Black	Angolo 90° interno e accessori / Inner 90° corner with accessories	53,47	
41141	Bianco / White	Angolo 90° interno e accessori / Inner 90° corner with accessories	53,47	

CODE	FINISHING	DESCRIPTION	KG	PRICE
41142	Nero / Black	Congiunzione elettrica con spinotti / Linear 65mm electric connection with relative 3-pins connector	8,51	
41143	Bianco / White	Congiunzione elettrica con spinotti / Linear 65mm electric connection with relative 3-pins connector	8,51	
41131	Nero / Black	Kit staffe incasso (2 pz) / Brackets for recessed installation (2 pcs)	13,37	
41222	Nero / Black	Staffe attacco soffitto kit 2pz / Brackets for ceiling installation 2 pcs	8,38	
41223	Bianco / White	Staffe attacco soffitto kit 2pz / Brackets for ceiling installation 2 pcs	8,38	
41132	Acciaio/Steel	Sospensione 2mt (1 pz) / Suspension 2mt (1 pc)	12,76	
41132/A	Nero / Black	Sospensione con cavo alimentazione 2mt (1 pz) / Suspension 2mt with electrical wire (1 pc)	12,76	
41133/A	Bianco / White	Sospensione con cavo alimentazione 2mt (1 pz) / Suspension 2mt with electrical wire (1 pc)	12,76	
41134	Nero / Black	Staffa connessione (1 pz) / Linear connection plate (1 pc)	4,85	
41135	Bianco / White	Staffa connessione (1 pz) / Linear connection plate (1 pc)	4,85	
41258	Nero / Black	Giunto a "X"/"X" connector	59,54	
41257	Bianco / White	Giunto a "X"/"X" connector	59,54	
41260	Nero / Black	Giunto a "T"/"T" connector	59,54	
41259	Bianco / White	Giunto a "T"/"T" connector	59,54	
41241	Nero / Black	Testata per alimentazione 24V/Front feed 24V	20,05	
41240	Bianco / White	Testata per alimentazione 24V/Front feed 24V	20,05	
41782	Nero / Black	Ponte di giunzione elettrica 168mm H.37mm/Electric bridge connector 168mm H.37mm	26,22	
41783	Bianco / White	Ponte di giunzione elettrica 168mm H.37mm/Electric bridge connector 168mm H.37mm	26,22	
42787	Nero / Black	Testata c/ driver 75W 230V dimm./Front feed w/ driver 75W 230V dimm.	0,70	181,06
42784	Bianco / White	Testata c/ driver 75W 230V dimm./Front feed w/ driver 75W 230V dimm.	0,70	181,06
42788	Nero / Black	Testata c/ driver 100W 230V dimm./Front feed w/ driver 100W 230V dimm.	0,70	198,08
42785	Bianco / White	Testata c/ driver 100W 230V dimm./Front feed w/ driver 100W 230V dimm.	0,70	198,08
42789	Nero / Black	Testata c/ driver 150W 230V dimm./Front feed w/ driver 150W 230V dimm.	0,80	241,82
42786	Bianco / White	Testata c/ driver 150W 230V dimm./Front feed w/ driver 150W 230V dimm.	0,80	241,82
42811	Nero / Black	Centrale c/ driver 75W 230V dimm./Central feed w/ driver 75W 230V dimm.	0,72	186,02
42808	Bianco / White	Centrale c/ driver 75W 230V dimm./Central feed w/ driver 75W 230V dimm.	0,72	186,02
42812	Nero / Black	Centrale c/ driver 100W 230V dimm./Central feed w/ driver 100W 230V dimm.	0,72	203,32
42809	Bianco / White	Centrale c/ driver 100W 230V dimm./Central feed w/ driver 100W 230V dimm.	0,72	203,32
42813	Nero / Black	Centrale c/ driver 150W 230V dimm./Central feed w/ driver 150W 230V dimm.	0,82	246,58
42810	Bianco / White	Centrale c/ driver 150W 230V dimm./Central feed w/ driver 150W 230V dimm.	0,82	246,58

DRIVER

CODE	WATT	VOLT	DESCRIPTION	MODE	SIZE	PRICE
22015	50W	24V DC	Driver MW	ON-OFF	99x82x30mm	34,45
22031	60W	24V DC	Driver EAGLERISE TRP	ON-OFF	187x45x31mm	39,69
22032	75W	24V DC	Driver EAGLERISE TRP	ON-OFF	187x45x31mm	50,72
22016	100W	24V DC	Driver MW	ON-OFF	129x97x30mm	61,74
22033	120W	24V DC	Driver EAGLERISE TRP	ON-OFF	268x45x31mm	65,05
22034	150W	24V DC	Driver EAGLERISE TRP	ON-OFF	268x45x31mm	83,79
22025	150W	24V DC	Driver MW	ON-OFF	160x95x30mm	65,05
22017	200W	24V DC	Driver MW	ON-OFF	215x115x30mm	132,30
41217	75W	24V DC	Driver dimmerabile LTECH	0-10V	294x43x30mm	153,61
41218	100W	24V DC	Driver dimmerabile LTECH	0-10V	240x70x36mm	169,66
41219	150W	24V DC	Driver dimmerabile LTECH	0-10V	354x43x30mm	214,37
11044	75W	24V DC	Driver LTECH	DALI	290x45x30mm	219,51
11045	150W	24V DC	Driver LTECH	DALI	290x45x30mm	301,40
11043	240W	24V DC	Driver LTECH	DALI	380x50x30mm	329,27

KLIK_KLAK MINI PROIETTORE

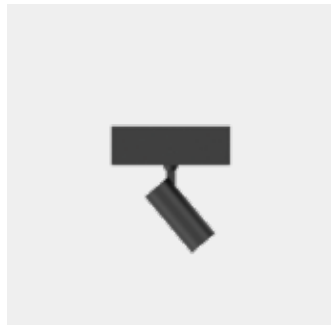

LED CREE
CRI >90
PF >0,5
SDCM <3

CODE	FINISHING	WATT	LUMEN	WATT LIGHT SOURCE	LUMEN LIGHT SOURCE	BEAM	KELVIN	KG	PRICE
41733	Nero/Black	6W	423	5W	630	30°	3000K	0,26	84,36
41734	Bianco/White	6W	423	5W	630	30°	3000K	0,26	84,36

INSTALLAZIONE APPLICATION

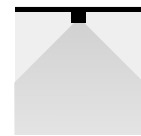

Binario magnetico/
Magnetic track

DISEGNI TECNICI TECHNICAL DRAWINGS

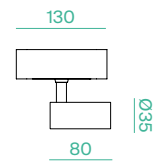

REGOLAZIONI ADJUSTABILITY



KLIK_KLAK MINI GLOBO

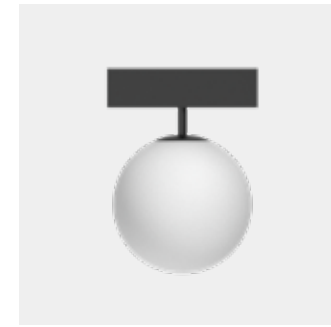

LED CREE
CRI >90
PF >0,5
SDCM <3

CODE	FINISHING	WATT	LUMEN	WATT LIGHT SOURCE	LUMEN LIGHT SOURCE	BEAM	KELVIN	KG	PRICE
41745	Nero/Black	10W	680	8W	1105	DIFF.	3000K	0,46	88,68
41746	Bianco/White	10W	680	8W	1105	DIFF.	3000K	0,46	88,68

INSTALLAZIONE APPLICATION

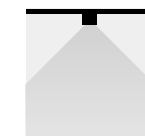

Binario magnetico/
Magnetic track

DISEGNI TECNICI TECHNICAL DRAWINGS

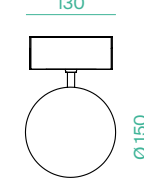

KLIK_KLAK MINI PROIETTORE

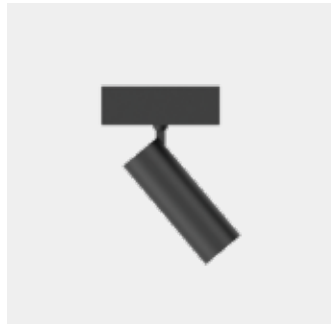

LED CREE
CRI >90
PF >0,5
SDCM <3

CODE	FINISHING	WATT	LUMEN	WATT LIGHT SOURCE	LUMEN LIGHT SOURCE	BEAM	KELVIN	KG	PRICE
41735	Nero/Black	10W	749	8W	900	36°	3000K	0,35	88,27
41736	Bianco/White	10W	749	8W	900	36°	3000K	0,35	88,27

INSTALLAZIONE APPLICATION

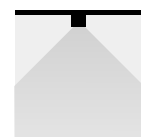

Binario magnetico/
Magnetic track

DISEGNI TECNICI TECHNICAL DRAWINGS

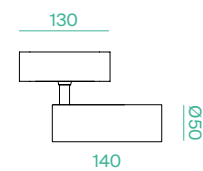

REGOLAZIONI ADJUSTABILITY



KLIK_KLAK MINI PUNTIFORME

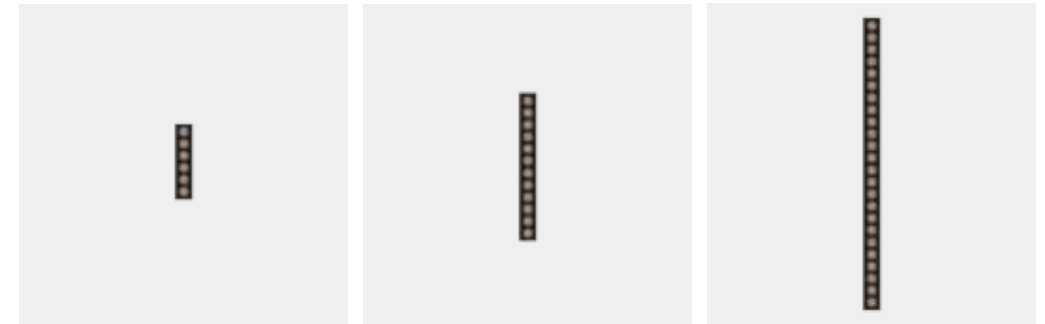

LED CREE
CRI >90
PF >0,7
SDCM <3

CODE	FINISHING	WATT	LUMEN	WATT LIGHT SOURCE	LUMEN LIGHT SOURCE	BEAM	KELVIN	KG	PRICE
41717	Nero/Black	6W	509	5W	693	30°	3000K	0,12	47,59
41718	Bianco/White	6W	509	5W	693	30°	3000K	0,12	47,59
41719	Nero/Black	12W	1011	10W	1410	30°	3000K	0,18	83,28
41720	Bianco/White	12W	1011	10W	1410	30°	3000K	0,18	83,28
41721	Nero/Black	24W	2041	20W	2750	30°	3000K	0,36	147,08
41722	Bianco/White	24W	2041	20W	2750	30°	3000K	0,36	147,08

INSTALLAZIONE APPLICATION

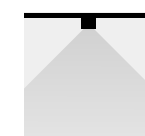

Binario magnetico/
Magnetic track

DISEGNI TECNICI TECHNICAL DRAWINGS

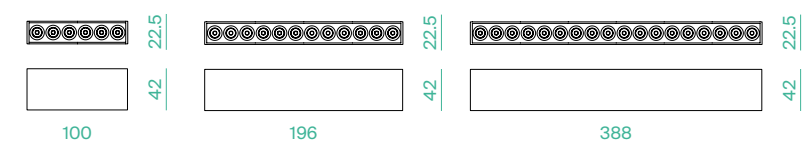

41717
41718

41719
41720

41721
41722



KLIK_KLAK MINI PUNTI FORME ORIENTABILE

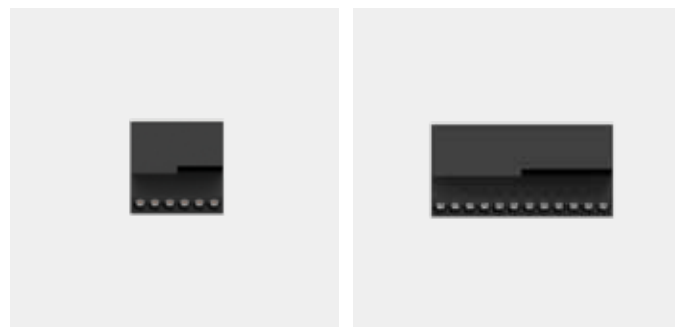

LED CREE
CRI >90
PF >0,7
SDCM <3

CODE	FINISHING	WATT	LUMEN	WATT LIGHT SOURCE	LUMEN LIGHT SOURCE	BEAM	KELVIN	KG	PRICE
41729	Nero/Black	8W	681	6W	819	30°	3000K	0,24	112,48
41730	Bianco/White	8W	681	6W	819	30°	3000K	0,24	112,48
41731	Nero/Black	16W	1198	12W	1647	30°	3000K	0,48	171,96
41732	Bianco/White	16W	1198	12W	1647	30°	3000K	0,48	171,96

INSTALLAZIONE APPLICATION

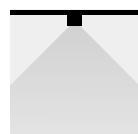

Binario magnetico/
Magnetic track

DISEGNI TECNICI TECHNICAL DRAWINGS

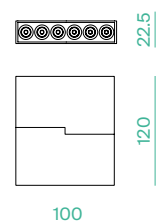

41729
41730

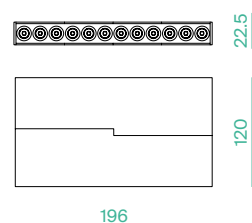

41731
41732

REGOLAZIONI ADJUSTABILITY



KLIK_KLAK MINI LUCÈ DIFFUSA

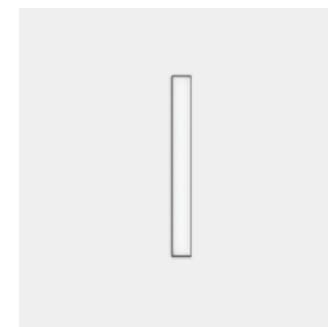

LED CREE
CRI >90
PF >0,7
SDCM <3

CODE	FINISHING	WATT	LUMEN	WATT LIGHT SOURCE	LUMEN LIGHT SOURCE	BEAM	KELVIN	KG	PRICE
41723	Nero/Black	8W	605	6W	950	105°	3000K	0,19	67,05
41724	Bianco/White	8W	605	6W	950	105°	3000K	0,19	67,05
41725	Nero/Black	15W	1013	12W	1900	105°	3000K	0,32	117,88
41726	Bianco/White	15W	1013	12W	1900	105°	3000K	0,32	117,88
41727	Nero/Black	30W	1970	23W	3420	105°	3000K	0,66	171,96
41728	Bianco/White	30W	1970	23W	3420	105°	3000K	0,66	171,96

INSTALLAZIONE APPLICATION



Binario magnetico/
Magnetic track

DISEGNI TECNICI TECHNICAL DRAWINGS

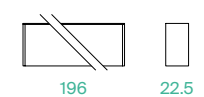

41723
41724

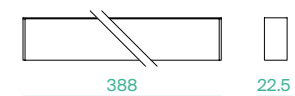

41725
41726

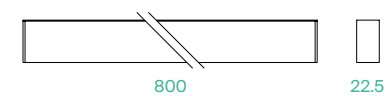

41727
41728

KLIK_KLAK MINI SOSPENSIONE



LED CREE
CRI >90
PF >0,5
SDCM <3

CODE	FINISHING	WATT	LUMEN	WATT LIGHT SOURCE	LUMEN LIGHT SOURCE	BEAM	KELVIN	KG	PRICE
41739	Nero/Black	6W	423	5W	630	30°	3000K	0,48	99,50
41740	Bianco/White	6W	423	5W	630	30°	3000K	0,48	99,50
41737	Nero/Black	10W	749	8W	900	36°	3000K	0,56	102,03
41738	Bianco/White	10W	749	8W	900	36°	3000K	0,56	102,03

INSTALLAZIONE APPLICATION

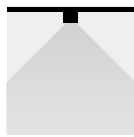

Binario magnetico/
Magnetic track

DISEGNI TECNICI TECHNICAL DRAWINGS

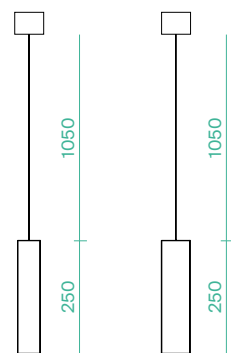

Ø35

41739
41740

Ø50

41737
41738



KLIK_KLAK MINI SOSPENSIONE GLOBO

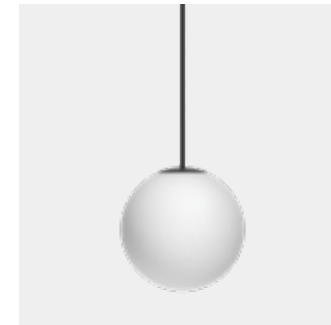

LED CREE
CRI >90
PF >0,5
SDCM <3

CODE	FINISHING	WATT	LUMEN	WATT LIGHT SOURCE	LUMEN LIGHT SOURCE	BEAM	KELVIN	KG	PRICE
41741	Nero/Black	10W	680	8W	1105	DIFF.	3000K	0,50	93,01
41742	Bianco/White	10W	680	8W	1105	DIFF.	3000K	0,50	93,01

INSTALLAZIONE APPLICATION



Binario magnetico/
Magnetic track

DISEGNI TECNICI TECHNICAL DRAWINGS



KLIK_KLAK MINI SOSPENSIONE BELL



LED CREE
CRI >90
PF >0,5
SDCM <3

CODE	FINISHING	WATT	LUMEN	WATT LIGHT SOURCE	LUMEN LIGHT SOURCE	BEAM	KELVIN	KG	PRICE
41743	Nero/Black	10W	415	8W	900	65°	3000K	0,44	89,76
41744	Bianco/White	10W	571	8W	900	65°	3000K	0,44	89,76

INSTALLAZIONE APPLICATION



Binario magnetico/
Magnetic track

DISEGNI TECNICI TECHNICAL DRAWINGS

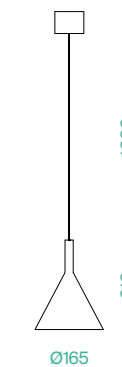

**KLIK_KLAK MINI
ACCESSORI
ACCESSORIES**

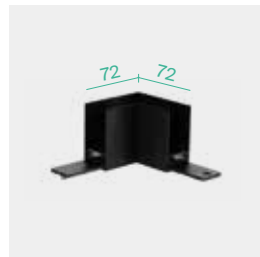

41747 - 41748

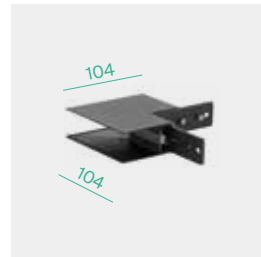

41751 - 41752



41749 - 41750

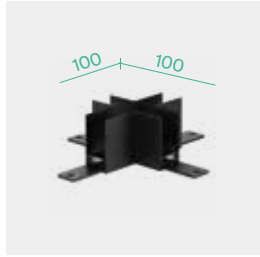

41753 - 41754

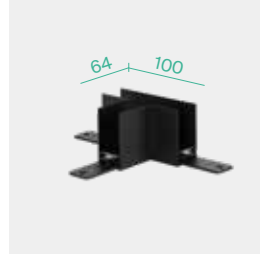

41755 - 41756



41759 - 41760

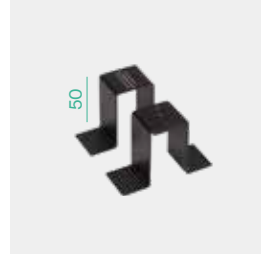

41763

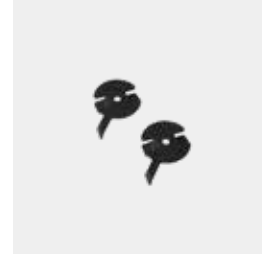

41761 - 41762



41132/A - 41133/A



41757 - 41758



41765 - 41766



41784 - 41788



41785 - 41789 - 41786 - 41790

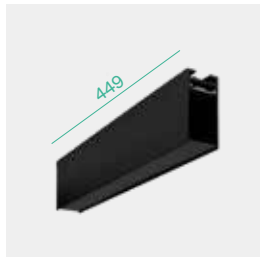

42817 - 42814



42818 - 42815 - 42819 - 42816

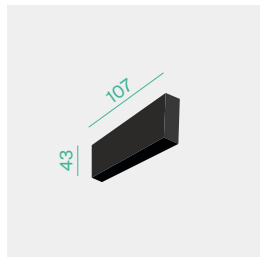

41780 - 41781

CODE	FINISHING	DESCRIPTION	KG	PRICE
41713	Nero / Black	Struttura 1mt in alluminio estruso con testate / 1mt extruded aluminium profile with end-caps	1,14	87,60
41714	Bianco / White	Struttura 1mt in alluminio estruso con testate / 1mt extruded aluminium profile with end-caps	1,14	87,60
41715	Nero / Black	Struttura 2mt in alluminio estruso con testate / 2mt extruded aluminium profile with end-caps	2,28	175,20
41716	Bianco / White	Struttura 2mt in alluminio estruso con testate / 2mt extruded aluminium profile with end-caps	2,28	175,20

**KLIK_KLAK MINI
ACCESSORI
ACCESSORIES**

CODE	FINISHING	DESCRIPTION	KG	PRICE
41764	Nero / Black	Copertura per rasatura 1 mt / 1 mt mask for plasterboard thinning		6,30
41747	Nero / Black	Angolo 90° con spinotti e accessori / 90° corner with accessories		49,75
41748	Bianco / White	Angolo 90° con spinotti e accessori / 90° corner with accessories		49,75
41751	Nero / Black	Angolo 90° esterno e accessori / Outer 90° corner with accessories		49,75
41752	Bianco / White	Angolo 90° esterno e accessori / Outer 90° corner with accessories		49,75
41749	Nero / Black	Angolo 90° interno e accessori / Inner 90° corner with accessories		49,75
41750	Bianco / White	Angolo 90° interno e accessori / Inner 90° corner with accessories		49,75
41759	Nero / Black	Congiunzione elettrica con spinotti / Linear electric connection with relative 3-pins connector		7,57
41760	Bianco / White	Congiunzione elettrica con spinotti / Linear electric connection with relative 3-pins connector		7,57
41763	Nero / Black	Kit staffe incasso (2 pz) / Brackets for recessed installation (2 pcs)		12,61
41761	Nero / Black	Staffe attacco soffitto kit 2pz / Brackets for ceiling installation 2 pcs		7,91
41762	Bianco / White	Staffe attacco soffitto kit 2pz / Brackets for ceiling installation 2 pcs		7,91
41132	Acciaio/Steel	Sospensione 2mt (1 pz) / Suspension 2mt (1 pc)		12,76
41132/A	Nero / Black	Sospensione con cavo alimentazione 2mt (1 pz) / Suspension 2mt with electrical wire (1 pc)		12,76
41133/A	Bianco / White	Sospensione con cavo alimentazione 2mt (1 pz) / Suspension 2mt with electrical wire (1 pc)		12,76
41757	Nero / Black	Staffa connessione (1 pz) / Linear connection plate (1 pc)		4,33
41758	Bianco / White	Staffa connessione (1 pz) / Linear connection plate (1 pc)		4,33
41753	Nero / Black	Giunto a "X"/"X" connector		55,16
41754	Bianco / White	Giunto a "X"/"X" connector		55,16
41755	Nero / Black	Giunto a "T"/"T" connector		55,16
41756	Bianco / White	Giunto a "T"/"T" connector		55,16
41765	Nero / Black	Testata per alimentazione 24V/Front feed 24V		18,91
41766	Bianco / White	Testata per alimentazione 24V/Front feed 24V		18,91
41780	Nero / Black	Ponte di giunzione elettrica 107mm H.43mm / Electric bridge connector 107mm H.43mm		26,22
41781	Bianco / White	Ponte di giunzione elettrica 107mm H.43mm / Electric bridge connector 107mm H.43mm		26,22
41784	Nero / Black	Testata c/ driver 60W 230V dimm./Front feed w/ driver 60W 230V dimm.	0,70	166,55
41788	Bianco / White	Testata c/ driver 60W 230V dimm./Front feed w/ driver 60W 230V dimm.	0,70	166,55
41785	Nero / Black	Testata c/ driver 100W 230V dimm./Front feed w/ driver 100W 230V dimm.	0,80	222,79
41789	Bianco / White	Testata c/ driver 100W 230V dimm./Front feed w/ driver 100W 230V dimm.	0,80	222,79
41786	Nero / Black	Testata c/ driver 150W 230V dimm./Front feed w/ driver 150W 230V dimm.	0,80	274,70
41790	Bianco / White	Testata c/ driver 150W 230V dimm./Front feed w/ driver 150W 230V dimm.	0,80	274,70
42817	Nero / Black	Centrale c/ driver 60W 230V dimm./Central feed w/ driver 60W 230V dimm.	0,72	171,96
42814	Bianco / White	Centrale c/ driver 60W 230V dimm./Central feed w/ driver 60W 230V dimm.	0,72	171,96
42818	Nero / Black	Centrale c/ driver 100W 230V dimm./Central feed w/ driver 100W 230V dimm.	0,82	229,28
42815	Bianco / White	Centrale c/ driver 100W 230V dimm./Central feed w/ driver 100W 230V dimm.	0,82	229,28
42819	Nero / Black	Centrale c/ driver 150W 230V dimm./Central feed w/ driver 150W 230V dimm.	0,82	280,11
42816	Bianco / White	Centrale c/ driver 150W 230V dimm./Central feed w/ driver 150W 230V dimm.	0,82	280,11

DRIVER

CODE	WATT	VOLT	DESCRIPTION	MODE	SIZE	PRICE
22015	50W	24V DC	Driver MW	ON-OFF	99x82x30mm	34,45
22031	60W	24V DC	Driver EAGLERISE TRP	ON-OFF	187x45x31mm	39,69
22032	75W	24V DC	Driver EAGLERISE TRP	ON-OFF	187x45x31mm	50,72
22016	100W	24V DC	Driver MW	ON-OFF	129x97x30mm	61,74
22033	120W	24V DC	Driver EAGLERISE TRP	ON-OFF	268x45x31mm	65,05
22034	150W	24V DC	Driver EAGLERISE TRP	ON-OFF	268x45x31mm	83,79
22025	150W	24V DC	Driver MW	ON-OFF	160x95x30mm	65,05
22017	200W	24V DC	Driver MW	ON-OFF	215x115x30mm	132,30
41217	75W	24V DC	Driver dimmerabile LTECH	0-10V	294x43x30mm	153,61
41218	100W	24V DC	Driver dimmerabile LTECH	0-10V	240x70x36mm	169,66
41219	150W	24V DC	Driver dimmerabile LTECH	0-10V	354x43x30mm	214,37
11044	75W	24V DC	Driver LTECH	DALI	290x45x30mm	219,51
11045	150W	24V DC	Driver LTECH	DALI	290x45x30mm	301,40
11043	240W	24V DC	Driver LTECH	DALI	380x50x30mm	329,27

KLIK_KLAK_MICRO PROIETTORE



LED CREE
CRI >90
PF >0,5
SDCM <3

CODE	FINISHING	WATT	LUMEN	WATT LIGHT SOURCE	LUMEN LIGHT SOURCE	BEAM	KELVIN	KG	PRICE
42835	Nero/Black	6W	423	5W	630	30°	3000K	0,20	84,36
42836	Bianco/White	6W	423	5W	630	30°	3000K	0,20	84,36
42837	Nero/Black	10W	749	8W	900	36°	3000K	0,20	88,27
42838	Bianco/White	10W	749	8W	900	36°	3000K	0,20	88,27

INSTALLAZIONE APPLICATION

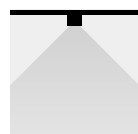

Binario magnetico/
Magnetic track

DISEGNI TECNICI TECHNICAL DRAWINGS

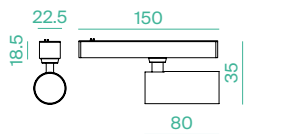

42835
42836

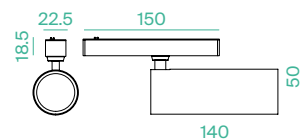

42837
42838

REGOLAZIONI ADJUSTABILITY



KLIK_KLAK_MICRO LUCÈ DIFFUSA



LED CREE
CRI >90
PF >0,7
SDCM <3

CODE	FINISHING	WATT	LUMEN	WATT LIGHT SOURCE	LUMEN LIGHT SOURCE	BEAM	KELVIN	KG	PRICE
42829	Nero/Black	12W	862	9W	1393	105°	3000K	0,25	112,27
42830	Bianco/White	12W	862	9W	1393	105°	3000K	0,25	112,27
42831	Nero/Black	18W	1270	14W	2067	105°	3000K	0,25	135,96
42832	Bianco/White	18W	1270	14W	2067	105°	3000K	0,25	135,96
42833	Nero/Black	24W	1705	18W	2752	105°	3000K	0,25	174,07
42834	Bianco/White	24W	1705	18W	2752	105°	3000K	0,25	174,07

INSTALLAZIONE APPLICATION



Binario magnetico/
Magnetic track

DISEGNI TECNICI TECHNICAL DRAWINGS

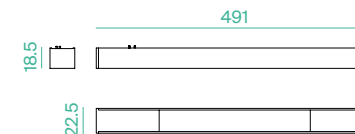

42829
42830



42831
42832

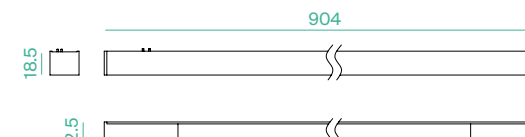

42833
42834

KLIK_KLAK_MICRO PUNTIFORME



LED CREE
CRI >90
PF >0,7
SDCM <3

CODE	FINISHING	WATT	LUMEN	WATT LIGHT SOURCE	LUMEN LIGHT SOURCE	BEAM	KELVIN	KG	PRICE
42825	Nero/Black	12W	1011	10W	1410	30°	3000K	0,15	73,13
42826	Bianco/White	12W	1011	10W	1410	30°	3000K	0,15	73,13
42827	Nero/Black	24W	2041	20W	2750	30°	3000K	0,15	132,87
42828	Bianco/White	24W	2041	20W	2750	30°	3000K	0,15	132,87

INSTALLAZIONE APPLICATION

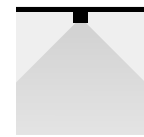

Binario magnetico/
Magnetic track

DISEGNI TECNICI TECHNICAL DRAWINGS

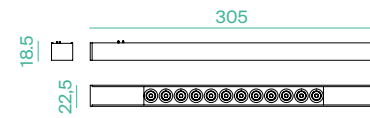

42825
42826

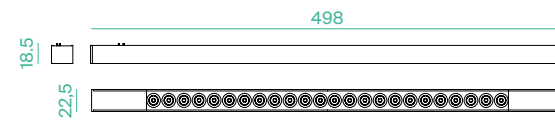

42827
42828



KLIK_KLAK_MICRO SOSPENSIONE

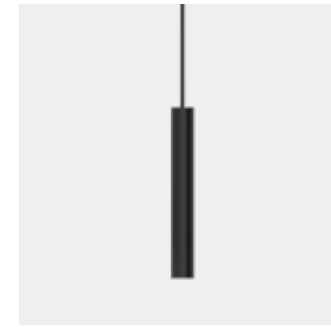

LED CREE
CRI >90
PF >0,5
SDCM <3

CODE	FINISHING	WATT	LUMEN	WATT LIGHT SOURCE	LUMEN LIGHT SOURCE	BEAM	KELVIN	KG	PRICE
42839	Nero/Black	6W	423	5W	630	30°	3000K	0,45	99,50
42840	Bianco/White	6W	423	5W	630	30°	3000K	0,45	99,50

INSTALLAZIONE APPLICATION

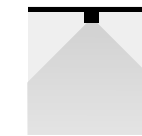

Binario magnetico/
Magnetic track

DISEGNI TECNICI TECHNICAL DRAWINGS

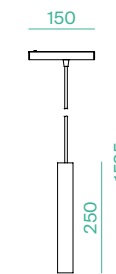

KLIK_KLAK_MICRO SOSPENSIONE BELL

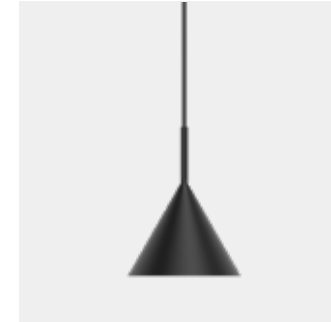

LED CREE
CRI >90
PF >0,5
SDCM <3

CODE	FINISHING	WATT	LUMEN	WATT LIGHT SOURCE	LUMEN LIGHT SOURCE	BEAM	KELVIN	KG	PRICE
42841	Nero/Black	10W	415	8W	900	65°	3000K	0,40	89,76
42842	Bianco/White	10W	571	8W	900	65°	3000K	0,40	89,76

INSTALLAZIONE APPLICATION



Binario magnetico/
Magnetic track

DISEGNI TECNICI TECHNICAL DRAWINGS

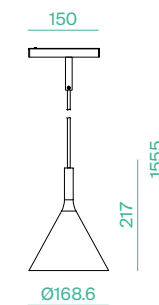

KLIK_KLAK MICRO
ACCESSORI
ACCESSORIES

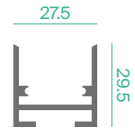

42843 - 42844

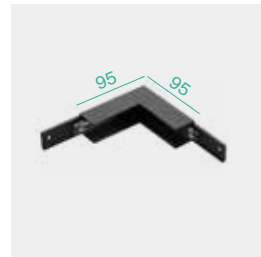

42845 - 42846

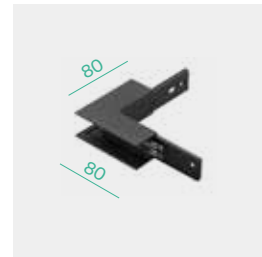

42847 - 42848

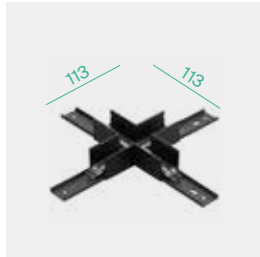

42849 - 42850

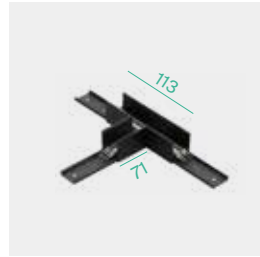

42851 - 42852

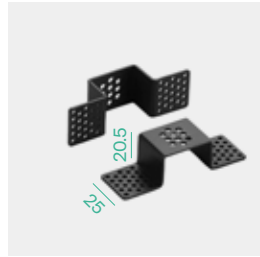

42853

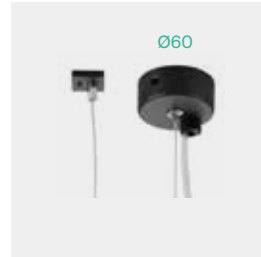

42854 - 42855

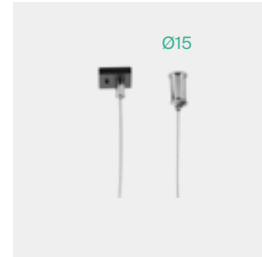

42856 - 42857

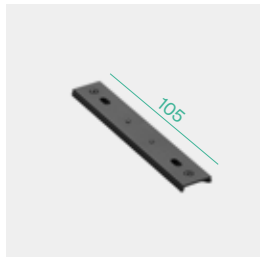

42858-42859



41759 - 41760



42862-42863

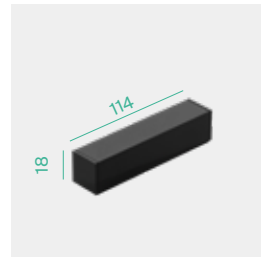

42864-42865

CODE	FINISHING	DESCRIPTION	KG	PRICE
42821	Nero / Black	Struttura 1mt in alluminio estruso con testate/ 1mt extruded aluminium profile with end-caps	0,80	71,07
42822	Bianco / White	Struttura 1mt in alluminio estruso con testate/ 1mt extruded aluminium profile with end-caps	0,80	71,07
42823	Nero / Black	Struttura 2mt in alluminio estruso con testate/ 2mt extruded aluminium profile with end-caps	1,55	140,08
42824	Bianco / White	Struttura 2mt in alluminio estruso con testate/ 2mt extruded aluminium profile with end-caps	1,55	140,08

KLIK_KLAK MICRO
ACCESSORI
ACCESSORIES

CODE	FINISHING	DESCRIPTION	PRICE
41764	Nero / Black	Copertura per rasatura 1 mt /1 mt mask for plasterboard thinning	6,30
42843	Nero / Black	Angolo 90° con spinotti e accessori/ 90° corner with accessories	47,90
42844	Bianco / White	Angolo 90° con spinotti e accessori/ 90° corner with accessories	47,90
42845	Nero / Black	Angolo 90° interno e accessori/ Inner 90° corner with accessories	47,90
42846	Bianco / White	Angolo 90° interno e accessori/ Inner 90° corner with accessories	47,90
42847	Nero / Black	Angolo 90° esterno e accessori/ Outer 90° corner with accessories	47,90
42848	Bianco / White	Angolo 90° esterno e accessori/ Outer 90° corner with accessories	47,90
42849	Nero / Black	Giunto a "X"/"X" connector	52,74
42850	Bianco / White	Giunto a "X"/"X" connector	52,74
42851	Nero / Black	Giunto a "T"/"T" connector	52,74
42852	Bianco / White	Giunto a "T"/"T" connector	52,74
42853	Nero / Black	Kit staffe incasso (2 pz) / Brackets for recessed installation (2 pcs)	11,85
42854	Nero / Black	Sospensione con cavo alimentazione 2mt (1 pz) / Suspension 2mt with electrical wire (1 pc)	12,76
42855	Bianco / White	Sospensione con cavo alimentazione 2mt (1 pz) / Suspension 2mt with electrical wire (1 pc)	12,76
42856	Nero / Black	Sospensione 2mt (1 pz) / Suspension 2mt (1 pc)	12,76
42857	Bianco / White	Sospensione 2mt (1 pz) / Suspension 2mt (1 pc)	12,76
42858	Nero / Black	Staffa connessione (1 pz) /Linear connection plate (1 pc)	4,33
42859	Bianco / White	Staffa connessione (1 pz) /Linear connection plate (1 pc)	4,33
41759	Nero / Black	Congiunzione elettrica con spinotti/ Linear electric connection with relative 3-pins connector	7,57
41760	Bianco / White	Congiunzione elettrica con spinotti/ Linear electric connection with relative 3-pins connector	7,57
42862	Nero / Black	Staffe attacco soffitto kit 2pz /Brackets for ceiling installation 2 pcs	7,91
42863	Bianco / White	Staffe attacco soffitto kit 2pz /Brackets for ceiling installation 2 pcs	7,91
42864	Nero / Black	Ponte di giunzione elettrica 114mm H.18mm/Electric bridge connector 114mm H.18mm	26,22
42865	Bianco / White	Ponte di giunzione elettrica 114mm H.18mm/Electric bridge connector 114mm H.18mm	26,22

DRIVER

CODE	WATT	VOLT	DESCRIPTION	MODE	SIZE	PRICE
22015	50W	24V DC	Driver MW	ON-OFF	99x82x30mm	34,45
22031	60W	24V DC	Driver EAGLERISE TRP	ON-OFF	187x45x31mm	39,69
22032	75W	24V DC	Driver EAGLERISE TRP	ON-OFF	187x45x31mm	50,72
22016	100W	24V DC	Driver MW	ON-OFF	129x97x30mm	61,74
22033	120W	24V DC	Driver EAGLERISE TRP	ON-OFF	268x45x31mm	65,05
22034	150W	24V DC	Driver EAGLERISE TRP	ON-OFF	268x45x31mm	83,79
22025	150W	24V DC	Driver MW	ON-OFF	160x95x30mm	65,05
22017	200W	24V DC	Driver MW	ON-OFF	215x115x30mm	132,30
41217	75W	24V DC	Driver dimmerabile LTECH	0-10V	294x43x30mm	153,61
41218	100W	24V DC	Driver dimmerabile LTECH	0-10V	240x70x36mm	169,66
41219	150W	24V DC	Driver dimmerabile LTECH	0-10V	354x43x30mm	214,37
11044	75W	24V DC	Driver LTECH	DALI	290x45x30mm	219,51
11045	150W	24V DC	Driver LTECH	DALI	290x45x30mm	301,40
11043	240W	24V DC	Driver LTECH	DALI	380x50x30mm	329,27

FULGOR 15W



LED BRIDGELUX
CRI >90
PF >0,9
SDCM ≥3

CODE	FINISHING	WATT	LUMEN	WATT LIGHT SOURCE	LUMEN LIGHT SOURCE	BEAM	KELVIN	VOLT	KG	PRICE
41797	Bianco/ White	15W	1560	14,8W	1710	15°	3000K	36-38V 350mA	0,40	66,56
41811	Nero/Black	15W	1560	14,8W	1710	15°	3000K	36-38V 350mA	0,40	66,56
41804	Bianco/ White	15W	1557	14,8W	1834	15°	4000K	36-38V 350mA	0,40	66,56
41818	Nero/Black	15W	1557	14,8W	1834	15°	4000K	36-38V 350mA	0,40	66,56
41798	Bianco/ White	15W	1574	14,8W	1710	24°	3000K	36-38V 350mA	0,40	66,56
41812	Nero/Black	15W	1574	14,8W	1710	24°	3000K	36-38V 350mA	0,40	66,56
41805	Bianco/ White	15W	1584	14,8W	1834	24°	4000K	36-38V 350mA	0,40	66,56
41819	Nero/Black	15W	1584	14,8W	1834	24°	4000K	36-38V 350mA	0,40	66,56
41799	Bianco/ White	15W	1591	14,8W	1710	38°	3000K	36-38V 350mA	0,40	66,56
41813	Nero/Black	15W	1591	14,8W	1710	38°	3000K	36-38V 350mA	0,40	66,56
41806	Bianco/ White	15W	1585	14,8W	1834	38°	4000K	36-38V 350mA	0,40	66,56
41820	Nero/Black	15W	1585	14,8W	1834	38°	4000K	36-38V 350mA	0,40	66,56
41800	Bianco/ White	15W	1509	14,8W	1710	55°	3000K	36-38V 350mA	0,40	66,56
41814	Nero/Black	15W	1509	14,8W	1710	55°	3000K	36-38V 350mA	0,40	66,56
41807	Bianco/ White	15W	1531	14,8W	1834	55°	4000K	36-38V 350mA	0,40	66,56
41821	Nero/Black	15W	1531	14,8W	1834	55°	4000K	36-38V 350mA	0,40	66,56

INSTALLAZIONE APPLICATION

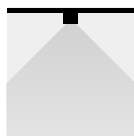

Binario/Track

DISEGNI TECNICI TECHNICAL DRAWINGS

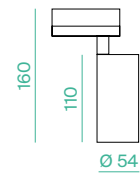

REGOLAZIONI ADJUSTABILITY



ACCESSORI ACCESSORIES

CODE	DESCRIPTION	PRICE
71575	Filtro honeycomb 15W/Honeycomb filter 15W	4,85

FULGOR 15W DALI-PUSH



LED BRIDGELUX
CRI >90
PF >0,9
SDCM ≥3

CODE	FINISHING	WATT	LUMEN	WATT LIGHT SOURCE	LUMEN LIGHT SOURCE	BEAM	KELVIN	VOLT	KG	PRICE
41825	Bianco/ White	15W	1560	14,8W	1710	15°	3000K	36-38V 350mA	0,40	102,00
41847	Nero/Black	15W	1560	14,8W	1710	15°	3000K	36-38V 350mA	0,40	102,00
41836	Bianco/ White	15W	1557	14,8W	1834	15°	4000K	36-38V 350mA	0,40	102,00
41858	Nero/Black	15W	1557	14,8W	1834	15°	4000K	36-38V 350mA	0,40	102,00
41826	Bianco/ White	15W	1574	14,8W	1710	24°	3000K	36-38V 350mA	0,40	102,00
41848	Nero/Black	15W	1574	14,8W	1710	24°	3000K	36-38V 350mA	0,40	102,00
41837	Bianco/ White	15W	1584	14,8W	1834	24°	4000K	36-38V 350mA	0,40	102,00
41859	Nero/Black	15W	1584	14,8W	1834	24°	4000K	36-38V 350mA	0,40	102,00
41827	Bianco/ White	15W	1591	14,8W	1710	38°	3000K	36-38V 350mA	0,40	102,00
41849	Nero/Black	15W	1591	14,8W	1710	38°	3000K	36-38V 350mA	0,40	102,00
41838	Bianco/ White	15W	1585	14,8W	1834	38°	4000K	36-38V 350mA	0,40	102,00
41860	Nero/Black	15W	1585	14,8W	1834	38°	4000K	36-38V 350mA	0,40	102,00
41828	Bianco/ White	15W	1509	14,8W	1710	55°	3000K	36-38V 350mA	0,40	102,00
41850	Nero/Black	15W	1509	14,8W	1710	55°	3000K	36-38V 350mA	0,40	102,00
41839	Bianco/ White	15W	1531	14,8W	1834	55°	4000K	36-38V 350mA	0,40	102,00
41861	Nero/Black	15W	1531	14,8W	1834	55°	4000K	36-38V 350mA	0,40	102,00

INSTALLAZIONE APPLICATION

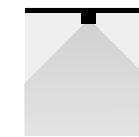

Binario/Track

DISEGNI TECNICI TECHNICAL DRAWINGS

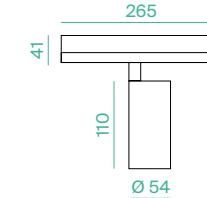

REGOLAZIONI ADJUSTABILITY



ACCESSORI ACCESSORIES

CODE	DESCRIPTION	PRICE
71575	Filtro honeycomb 15W/Honeycomb filter 15W	4,85

FULGOR 24W



LED BRIDGELUX
CRI >90
PF >0,9
SDCM ≥3

CODE	FINISHING	WATT	LUMEN	WATT LIGHT SOURCE	LUMEN LIGHT SOURCE	BEAM	KELVIN	VOLT	KG	PRICE
41678	Bianco/ White	24W	2220	24W	2640	15°	3000K	36-38V 600mA	0,60	79,60
41679	Nero/Black	24W	2220	24W	2640	15°	3000K	36-38V 600mA	0,60	79,60
41680	Bianco/ White	24W	2400	24W	2880	15°	4000K	36-38V 600mA	0,60	79,60
41681	Nero/Black	24W	2400	24W	2880	15°	4000K	36-38V 600mA	0,60	79,60
41674	Bianco/ White	24W	2280	24W	2640	24°	3000K	36-38V 600mA	0,60	79,60
41675	Nero/Black	24W	2280	24W	2640	24°	3000K	36-38V 600mA	0,60	79,60
41676	Bianco/ White	24W	2480	24W	2880	24°	4000K	36-38V 600mA	0,60	79,60
41677	Nero/Black	24W	2480	24W	2880	24°	4000K	36-38V 600mA	0,60	79,60
41670	Bianco/ White	24W	2340	24W	2640	38°	3000K	36-38V 600mA	0,60	79,60
41671	Nero/Black	24W	2340	24W	2640	38°	3000K	36-38V 600mA	0,60	79,60
41672	Bianco/ White	24W	2550	24W	2880	38°	4000K	36-38V 600mA	0,60	79,60
41673	Nero/Black	24W	2550	24W	2880	38°	4000K	36-38V 600mA	0,60	79,60
41666	Bianco/ White	24W	2310	24W	2640	55°	3000K	36-38V 600mA	0,60	79,60
41668	Nero/Black	24W	2310	24W	2640	55°	3000K	36-38V 600mA	0,60	79,60
41667	Bianco/ White	24W	2510	24W	2880	55°	4000K	36-38V 600mA	0,60	79,60
41669	Nero/Black	24W	2510	24W	2880	55°	4000K	36-38V 600mA	0,60	79,60

INSTALLAZIONE APPLICATION

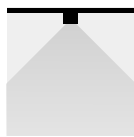

Binario/Track

DISEGNI TECNICI TECHNICAL DRAWINGS

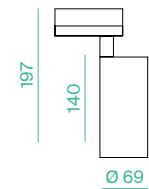

REGOLAZIONI ADJUSTABILITY



ACCESSORI ACCESSORIES

CODE	DESCRIPTION	PRICE
71663	Filtro honeycomb 24W/Honeycomb filter 24W	5,46

FULGOR 24W DALI-PUSH



LED BRIDGELUX
CRI >90
PF >0,9
SDCM ≥3

CODE	FINISHING	WATT	LUMEN	WATT LIGHT SOURCE	LUMEN LIGHT SOURCE	BEAM	KELVIN	VOLT	KG	PRICE
41829	Bianco/ White	24W	2220	24W	2640	15°	3000K	36-38V 600mA	0,60	118,00
41851	Nero/Black	24W	2220	24W	2640	15°	3000K	36-38V 600mA	0,60	118,00
41840	Bianco/ White	24W	2400	24W	2880	15°	4000K	36-38V 600mA	0,60	118,00
41862	Nero/Black	24W	2400	24W	2880	15°	4000K	36-38V 600mA	0,60	118,00
41830	Bianco/ White	24W	2280	24W	2640	24°	3000K	36-38V 600mA	0,60	118,00
41852	Nero/Black	24W	2280	24W	2640	24°	3000K	36-38V 600mA	0,60	118,00
41841	Bianco/ White	24W	2480	24W	2880	24°	4000K	36-38V 600mA	0,60	118,00
41863	Nero/Black	24W	2480	24W	2880	24°	4000K	36-38V 600mA	0,60	118,00
41831	Bianco/ White	24W	2340	24W	2640	38°	3000K	36-38V 600mA	0,60	118,00
41853	Nero/Black	24W	2340	24W	2640	38°	3000K	36-38V 600mA	0,60	118,00
41842	Bianco/ White	24W	2550	24W	2880	38°	4000K	36-38V 600mA	0,60	118,00
41864	Nero/Black	24W	2550	24W	2880	38°	4000K	36-38V 600mA	0,60	118,00
41832	Bianco/ White	24W	2310	24W	2640	55°	3000K	36-38V 600mA	0,60	118,00
41854	Nero/Black	24W	2310	24W	2640	55°	3000K	36-38V 600mA	0,60	118,00
41843	Bianco/ White	24W	2510	24W	2880	55°	4000K	36-38V 600mA	0,60	118,00
41865	Nero/Black	24W	2510	24W	2880	55°	4000K	36-38V 600mA	0,60	118,00

INSTALLAZIONE APPLICATION

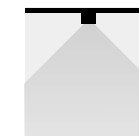

Binario/Track

DISEGNI TECNICI TECHNICAL DRAWINGS

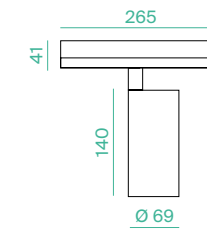

REGOLAZIONI ADJUSTABILITY



ACCESSORI ACCESSORIES

CODE	DESCRIPTION	PRICE
71663	Filtro honeycomb 24W/Honeycomb filter 24W	5,46

FULGOR 35W



LED BRIDGELUX
CRI >90
PF >0,9
SDCM ≥3

CODE	FINISHING	WATT	LUMEN	WATT LIGHT SOURCE	LUMEN LIGHT SOURCE	BEAM	KELVIN	VOLT	KG	PRICE
41801	Bianco/ White	35W	3267	33,5W	3705	15°	3000K	36-38V 850mA	0,86	98,57
41815	Nero/Black	35W	3267	33,5W	3705	15°	3000K	36-38V 850mA	0,86	98,57
41808	Bianco/ White	35W	3405	33,5W	3973	15°	4000K	36-38V 850mA	0,86	98,57
41822	Nero/Black	35W	3405	33,5W	3973	15°	4000K	36-38V 850mA	0,86	98,57
41802	Bianco/ White	35W	3408	33,5W	3705	24°	3000K	36-38V 850mA	0,86	98,57
41816	Nero/Black	35W	3408	33,5W	3705	24°	3000K	36-38V 850mA	0,86	98,57
41809	Bianco/ White	35W	3462	33,5W	3973	24°	4000K	36-38V 850mA	0,86	98,57
41823	Nero/Black	35W	3462	33,5W	3973	24°	4000K	36-38V 850mA	0,86	98,57
41803	Bianco/ White	35W	3370	33,5W	3705	38°	3000K	36-38V 850mA	0,86	98,57
41817	Nero/Black	35W	3370	33,5W	3705	38°	3000K	36-38V 850mA	0,86	98,57
41810	Bianco/ White	35W	3483	33,5W	3973	38°	4000K	36-38V 850mA	0,86	98,57
41824	Nero/Black	35W	3483	33,5W	3973	38°	4000K	36-38V 850mA	0,86	98,57
41905	Bianco/ White	35W	3410	33,5W	3705	55°	3000K	36-38V 850mA	0,86	98,57
41906	Nero/Black	35W	3410	33,5W	3705	55°	3000K	36-38V 850mA	0,86	98,57
41907	Bianco/ White	35W	3451	33,5W	3973	55°	4000K	36-38V 850mA	0,86	98,57
41908	Nero/Black	35W	3451	33,5W	3973	55°	4000K	36-38V 850mA	0,86	98,57

INSTALLAZIONE APPLICATION

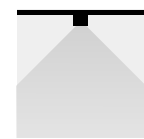

Binario/Track

DISEGNI TECNICI TECHNICAL DRAWINGS

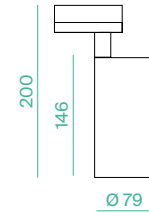

REGOLAZIONI ADJUSTABILITY



ACCESSORI ACCESSORIES

CODE	DESCRIPTION	PRICE
71664	Filtro honeycomb 35W/Honeycomb filter 35W	5,86

FULGOR 35W DALI-PUSH



LED BRIDGELUX
CRI >90
PF >0,9
SDCM ≥3

CODE	FINISHING	WATT	LUMEN	WATT LIGHT SOURCE	LUMEN LIGHT SOURCE	BEAM	KELVIN	VOLT	KG	PRICE
41833	Bianco/ White	35W	3267	33,5W	3705	15°	3000K	36-38V 850mA	0,86	132,00
41855	Nero/Black	35W	3267	33,5W	3705	15°	3000K	36-38V 850mA	0,86	132,00
41844	Bianco/ White	35W	3405	33,5W	3973	15°	4000K	36-38V 850mA	0,86	132,00
41866	Nero/Black	35W	3405	33,5W	3973	15°	4000K	36-38V 850mA	0,86	132,00
41834	Bianco/ White	35W	3408	33,5W	3705	24°	3000K	36-38V 850mA	0,86	132,00
41856	Nero/Black	35W	3408	33,5W	3705	24°	3000K	36-38V 850mA	0,86	132,00
41845	Bianco/ White	35W	3462	33,5W	3973	24°	4000K	36-38V 850mA	0,86	132,00
41867	Nero/Black	35W	3462	33,5W	3973	24°	4000K	36-38V 850mA	0,86	132,00
41835	Bianco/ White	35W	3370	33,5W	3705	38°	3000K	36-38V 850mA	0,86	132,00
41857	Nero/Black	35W	3370	33,5W	3705	38°	3000K	36-38V 850mA	0,86	132,00
41846	Bianco/ White	35W	3483	33,5W	3973	38°	4000K	36-38V 850mA	0,86	132,00
41868	Nero/Black	35W	3483	33,5W	3973	38°	4000K	36-38V 850mA	0,86	132,00
41909	Bianco/ White	35W	3410	33,5W	3705	55°	3000K	36-38V 850mA	0,86	132,00
41910	Nero/Black	35W	3410	33,5W	3705	55°	3000K	36-38V 850mA	0,86	132,00
41911	Bianco/ White	35W	3451	33,5W	3973	55°	4000K	36-38V 850mA	0,86	132,00
41912	Nero/Black	35W	3451	33,5W	3973	55°	4000K	36-38V 850mA	0,86	132,00

INSTALLAZIONE APPLICATION

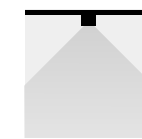

Binario/Track

DISEGNI TECNICI TECHNICAL DRAWINGS

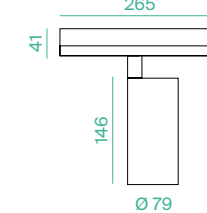

REGOLAZIONI ADJUSTABILITY



ACCESSORI ACCESSORIES

CODE	DESCRIPTION	PRICE
71664	Filtro honeycomb 35W/Honeycomb filter 35W	5,86

BOMBO 24W



LED BRIDGELUX
CRI >90
PF 0,9
SDCM ≥3

CODE	FINISHING	WATT	LUMEN	WATT LIGHT SOURCE	LUMEN LIGHT SOURCE	BEAM	KELVIN	VOLT	KG	PRICE
71974	Bianco/ White	24W	2189	22W	2780	15°	3000K	30-42V/600mA	0,46	67,20
71975	Nero/Black	24W	2189	22W	2780	15°	3000K	30-42V/600mA	0,46	67,20
71976	Bianco/ White	24W	2238	22W	2838	15°	4000K	30-42V/600mA	0,46	67,20
71977	Nero/Black	24W	2238	22W	2838	15°	4000K	30-42V/600mA	0,46	67,20
71978	Bianco/ White	24W	2167	22W	2780	24°	3000K	30-42V/600mA	0,46	67,20
71979	Nero/Black	24W	2167	22W	2780	24°	3000K	30-42V/600mA	0,46	67,20
71980	Bianco/ White	24W	2273	22W	2838	24°	4000K	30-42V/600mA	0,46	67,20
71981	Nero/Black	24W	2273	22W	2838	24°	4000K	30-42V/600mA	0,46	67,20
71982	Bianco/ White	24W	2125	22W	2780	38°	3000K	30-42V/600mA	0,46	67,20
71983	Nero/Black	24W	2125	22W	2780	38°	3000K	30-42V/600mA	0,46	67,20
71984	Bianco/ White	24W	2273	22W	2838	38°	4000K	30-42V/600mA	0,46	67,20
71985	Nero/Black	24W	2273	22W	2838	38°	4000K	30-42V/600mA	0,46	67,20
71986	Bianco/ White	24W	2100	22W	2780	55°	3000K	30-42V/600mA	0,46	67,20
71987	Nero/Black	24W	2100	22W	2780	55°	3000K	30-42V/600mA	0,46	67,20
71988	Bianco/ White	24W	2210	22W	2838	55°	4000K	30-42V/600mA	0,46	67,20
71989	Nero/Black	24W	2210	22W	2838	55°	4000K	30-42V/600mA	0,46	67,20

INSTALLAZIONE APPLICATION

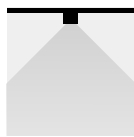

Binario/Track

DISEGNI TECNICI TECHNICAL DRAWINGS

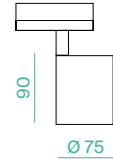

REGOLAZIONI ADJUSTABILITY



BOMBO 32W

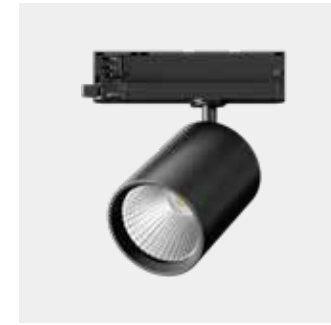

LED BRIDGELUX
CRI >90
PF 0,9
SDCM ≥3

CODE	FINISHING	WATT	LUMEN	WATT LIGHT SOURCE	LUMEN LIGHT SOURCE	BEAM	KELVIN	VOLT	KG	PRICE
71998	Bianco/ White	32W	3005	29W	3820	15°	3000K	30-42V/800mA	0,59	82,88
71999	Nero/Black	32W	3005	29W	3820	15°	3000K	30-42V/800mA	0,59	82,88
72000	Bianco/ White	32W	3219	29W	4204	15°	4000K	30-42V/800mA	0,59	82,88
72001	Nero/Black	32W	3219	29W	4204	15°	4000K	30-42V/800mA	0,59	82,88
72002	Bianco/ White	32W	2895	29W	3820	24°	3000K	30-42V/800mA	0,59	82,88
72003	Nero/Black	32W	2895	29W	3820	24°	3000K	30-42V/800mA	0,59	82,88
72004	Bianco/ White	32W	3280	29W	4204	24°	4000K	30-42V/800mA	0,59	82,88
72005	Nero/Black	32W	3280	29W	4204	24°	4000K	30-42V/800mA	0,59	82,88
72006	Bianco/ White	32W	2877	29W	3820	38°	3000K	30-42V/800mA	0,59	82,88
72007	Nero/Black	32W	2877	29W	3820	38°	3000K	30-42V/800mA	0,59	82,88
72008	Bianco/ White	32W	3222	29W	4204	38°	4000K	30-42V/800mA	0,59	82,88
72009	Nero/Black	32W	3222	29W	4204	38°	4000K	30-42V/800mA	0,59	82,88
72010	Bianco/ White	32W	2861	29W	3820	55°	3000K	30-42V/800mA	0,59	82,88
72011	Nero/Black	32W	2861	29W	3820	55°	3000K	30-42V/800mA	0,59	82,88
72012	Bianco/ White	32W	3153	29W	4204	55°	4000K	30-42V/800mA	0,59	82,88
72013	Nero/Black	32W	3153	29W	4204	55°	4000K	30-42V/800mA	0,59	82,88

INSTALLAZIONE APPLICATION

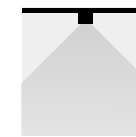

Binario/Track

DISEGNI TECNICI TECHNICAL DRAWINGS

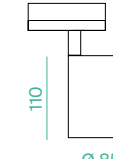

REGOLAZIONI ADJUSTABILITY



SUN_111 TRACK

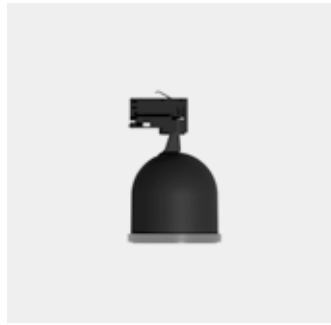

Lampadina esclusa / Bulb not included

CODE	FINISHING	BASE	WATT	VOLTAGE	KG	PRICE
41913	Bianco/White	AR111 GU10	Max 50W	230V 50/60Hz	0,44	38,01
41914	Nero/Black	AR111 GU10	Max 50W	230V 50/60Hz	0,44	38,01

INSTALLAZIONE APPLICATION

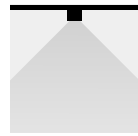

Binario/Track

DISEGNI TECNICI TECHNICAL DRAWINGS

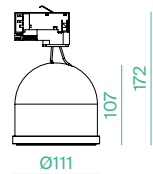

REGOLAZIONI ADJUSTABILITY



UNICO DICRO TRACK

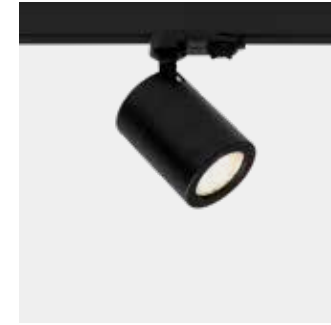

Lampadina esclusa / Bulb not included

CODE	FINISHING	BASE	VOLT	KG	PRICE
40758	Bianco/White	GU10	230V 50/60HZ	0,30	51,64
40759	Nero/Black	GU10	230V 50/60HZ	0,30	51,64

INSTALLAZIONE APPLICATION

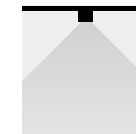

Binario/Track

DISEGNI TECNICI TECHNICAL DRAWINGS

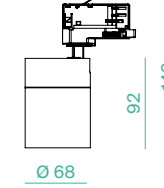

REGOLAZIONI ADJUSTABILITY



UNICO AR111 TRACK

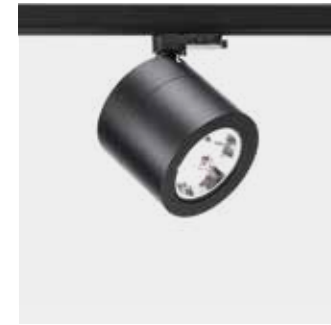

Lampadina esclusa / Bulb not included

CODE	FINISHING	BASE	VOLT	KG	PRICE
40754	Bianco/White	GU10	230V 50/60HZ	0,50	69,14
40755	Nero/Black	GU10	230V 50/60HZ	0,50	69,14

INSTALLAZIONE APPLICATION

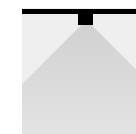

Binario/Track

DISEGNI TECNICI TECHNICAL DRAWINGS

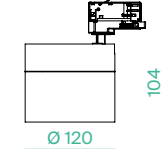

REGOLAZIONI ADJUSTABILITY

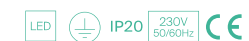

CILINDRO TRACK



LED CREE
CRI >90
PF >0.5
SDCM <3

CODE	FINISHING	WATT	LUMEN	WATT LIGHT SOURCE	LUMEN LIGHT SOURCE	BEAM	KELVIN	KG	PRICE
41927	Nero/Black	10W	749	8W	900	36°	3000K	0,40	108,15
41928	Bianco/White	10W	749	8W	900	36°	3000K	0,40	108,15

INSTALLAZIONE APPLICATION

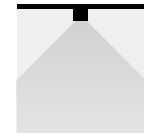

Binario/Track

DISEGNI TECNICI TECHNICAL DRAWINGS

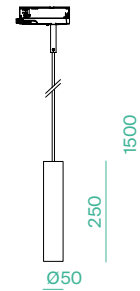

BELL TRACK

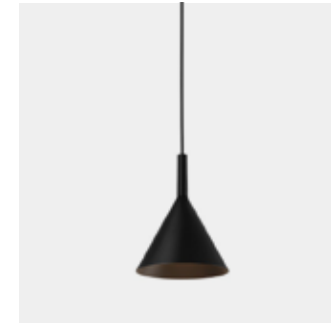

LED CREE
CRI >90
PF >0.5
SDCM <3

CODE	FINISHING	WATT	LUMEN	WATT LIGHT SOURCE	LUMEN LIGHT SOURCE	BEAM	KELVIN	KG	PRICE
41925	Nero/Black	10W	415	8W	900	65°	3000K	0,40	89,76
41926	Bianco/White	10W	571	8W	900	65°	3000K	0,40	89,76

INSTALLAZIONE APPLICATION



Binario/Track

DISEGNI TECNICI TECHNICAL DRAWINGS

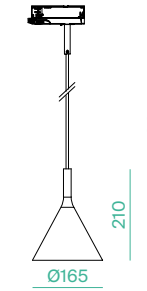

GLOBO TRACK



LED CREE
CRI >90
PF >0.5
SDCM <3

CODE	FINISHING	WATT	LUMEN	WATT LIGHT SOURCE	LUMEN LIGHT SOURCE	BEAM	KELVIN	KG	PRICE
41923	Nero/Black	10W	680	8W	1105	Diff.	3000K	0,45	93,01
41924	Bianco/White	10W	680	8W	1105	Diff.	3000K	0,45	93,01

INSTALLAZIONE APPLICATION

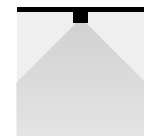

Binario/Track

DISEGNI TECNICI TECHNICAL DRAWINGS

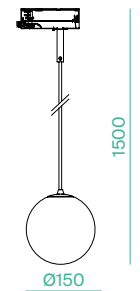

INVISIBILE IN-TRACK



LED SEOUL
CRI >90
PF >0.95
SDCM <6

CODE	FINISHING	WATT	LUMEN	WATT LIGHT SOURCE	LUMEN LIGHT SOURCE	BEAM	KELVIN	KG	PRICE
60147	Bianco/White	20W	2400	16,8W	2700	48°	3000K	0,25	99,00
60148	Nero/Black	20W	2400	16,8W	2700	48°	3000K	0,25	99,00
60149	Bianco/White	20W	2500	16,8W	2800	48°	4000K	0,25	99,00
60150	Nero/Black	20W	2500	16,8W	2800	48°	4000K	0,25	99,00
60151	Bianco/White	30W	3600	25W	4200	48°	3000K	0,34	121,00
60152	Nero/Black	30W	3600	25W	4200	48°	3000K	0,34	121,00
60153	Bianco/White	30W	3700	25W	4300	48°	4000K	0,34	121,00
60154	Nero/Black	30W	3700	25W	4300	48°	4000K	0,34	121,00

INSTALLAZIONE APPLICATION

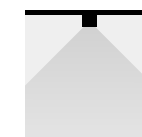

Binario/Track

DISEGNI TECNICI TECHNICAL DRAWINGS

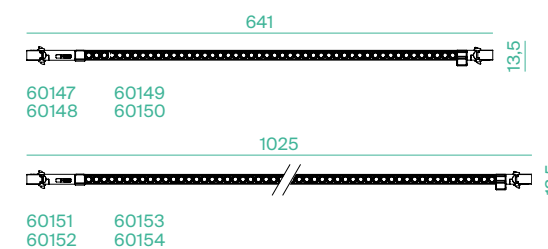

STREAMLIGHT



LED SAMSUNG
CRI >82
PF 0,9

CODE	MODEL	FINISHING	WATT	LUMEN	WATT LIGHT SOURCE	LUMEN LIGHT SOURCE	BEAM	KELVIN	KG	PRICE
41094	Asymmetric A	Bianco/White	55W	5300	47W	6625	25°	3000K	1,00	200,50
41095	Asymmetric A	Bianco/White	55W	5700	47W	7125	25°	4000K	1,00	200,50
41098	Asymmetric A	Nero/Black	55W	5300	47W	6625	25°	3000K	1,00	200,50
41099	Asymmetric A	Nero/Black	55W	5700	47W	7125	25°	4000K	1,00	200,50
41096	Asymmetric B	Bianco/White	55W	5300	47W	6625	25°	3000K	1,00	200,50
41097	Asymmetric B	Bianco/White	55W	5700	47W	7125	25°	4000K	1,00	200,50
41100	Asymmetric B	Nero/Black	55W	5300	47W	6625	25°	3000K	1,00	200,50
41101	Asymmetric B	Nero/Black	55W	5700	47W	7125	25°	4000K	1,00	200,50
41102	Symmetric	Bianco/White	55W	5300	47W	6625	85°*85°	3000K	1,00	200,50
41103	Symmetric	Bianco/White	55W	5700	47W	7125	85°*85°	4000K	1,00	200,50
41104	Symmetric	Nero/Black	55W	5300	47W	6625	85°*85°	3000K	1,00	200,50
41105	Symmetric	Nero/Black	55W	5700	47W	7125	85°*85°	4000K	1,00	200,50

INSTALLAZIONE APPLICATION

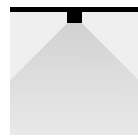

Binario/Track

ASYMMETRIC A

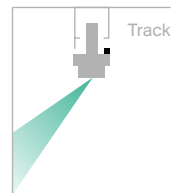

ASYMMETRIC B

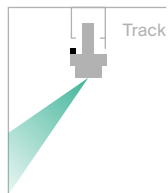

DISEGNI TECNICI TECHNICAL DRAWINGS

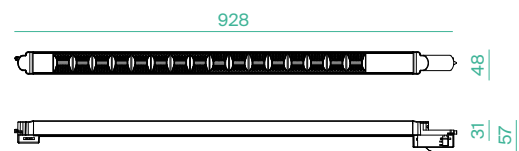

TRACKS

CODE	FINISHING	DESCRIPTION	KG	PRICE
60037	Nero/Black	Euro-track binario/track 1 mt.	0,90	35,62
60040	Nero/Black	Euro-track binario/track 2 mt.	1,80	65,63
60043	Nero/Black	Euro-track binario/track 3 mt.	2,70	95,84
60038	Bianco/White	Euro-track binario/track 1 mt.	0,90	35,62
60041	Bianco/White	Euro-track binario/track 2 mt.	1,80	65,63
60044	Bianco/White	Euro-track binario/track 3 mt.	2,70	95,84

INSTALLAZIONE APPLICATION

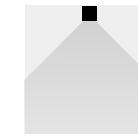

Soffitto/Ceiling

DISEGNI TECNICI TECHNICAL DRAWINGS

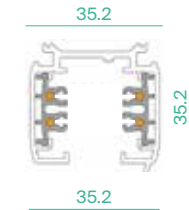

TRACKS INCASSO

CODE	FINISHING	DESCRIPTION	KG	PRICE
60100	Nero/Black	Euro-track binario incasso/ Recessed track 2 mt.	2,00	77,21
60102	Nero/Black	Euro-track binario incasso/ Recessed track 3 mt.	3,00	112,75
60101	Bianco/White	Euro-track binario incasso/ Recessed track 2 mt.	2,00	77,21
60103	Bianco/White	Euro-track binario incasso/ Recessed track 3 mt.	3,00	112,75

INSTALLAZIONE APPLICATION

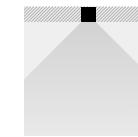

Incasso/Recessed

DISEGNI TECNICI TECHNICAL DRAWINGS

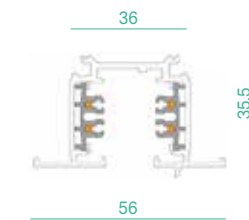

ACCESSORI
ACCESSORIES

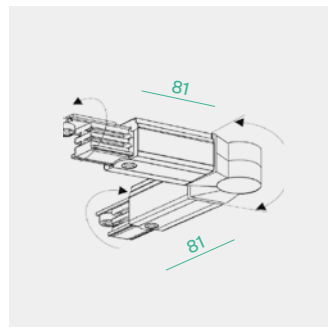

60046 - 60047

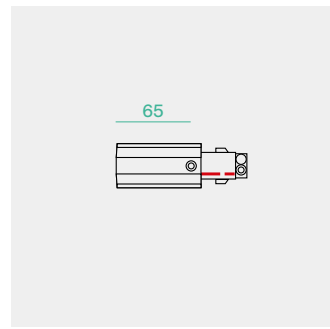

60049 - 60050

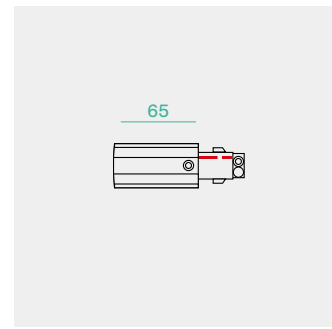

60052 - 60053

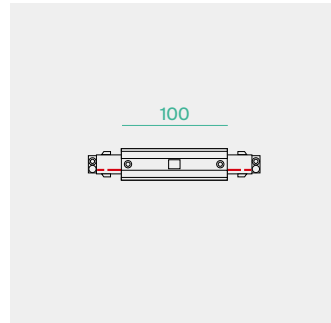

60084 - 60085

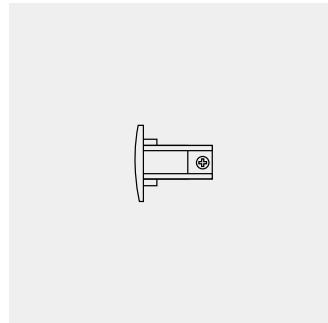

60055 - 60056



60088 - 60089

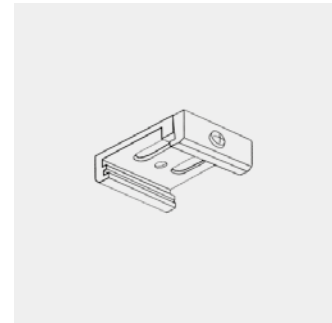

60086 - 60087

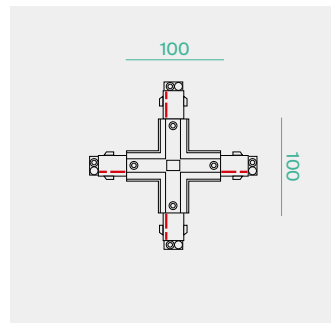

60079 - 60080

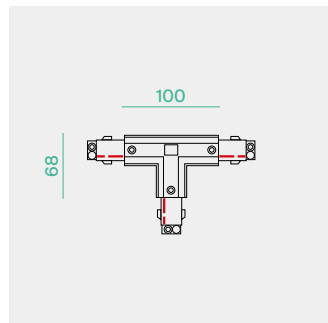

60067 - 60068

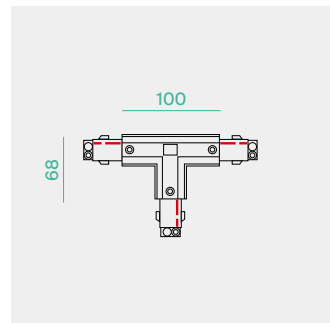

60070 - 60071

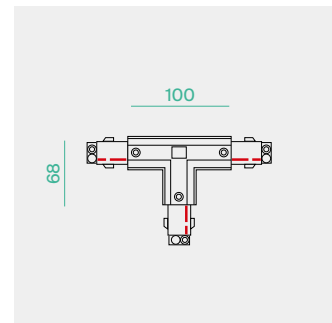

60073 - 60074

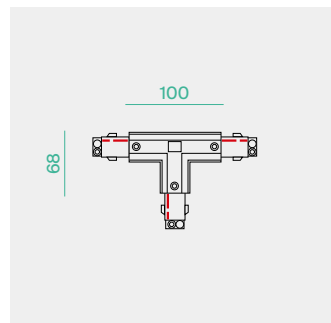

60076 - 60077

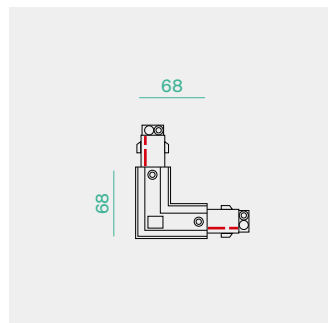

60061 - 60062

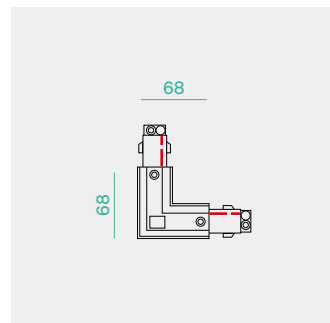

60064 - 60065

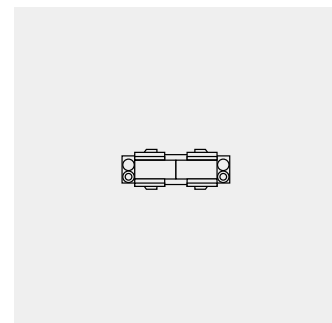

60058 - 60059

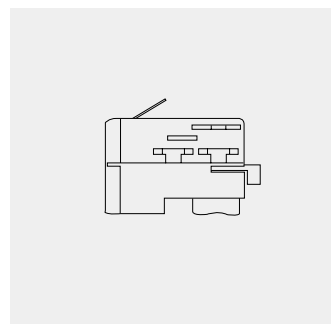

52582/N - 52582/B



11620 - 11621

ACCESSORI
ACCESSORIES

CODE	FINISHING	DESCRIPTION	PRICE
60046	Nero/Black	Curva regolabile/Adjustable junction	24,47
60047	Bianco/White	Curva regolabile/Adjustable junction	24,47
60049	Nero/Black	Alimentazione sinistra/Left feed	12,37
60050	Bianco/White	Alimentazione sinistra/Left feed	12,37
60052	Nero/Black	Alimentazione destra/Right feed	12,37
60053	Bianco/White	Alimentazione destra/Right feed	12,37
60084	Nero/Black	Alimentazione centrale/Middle feed	22,41
60085	Bianco/White	Alimentazione centrale/Middle feed	22,41
60055	Nero/Black	Testata di chiusura/End-cap	1,58
60056	Bianco/White	Testata di chiusura/End-cap	1,58
60088	Nero/Black	Kit sospensione con cavo 2 mt./Suspension kit with cable 2 mt.	13,88
60089	Bianco/White	Kit sospensione con cavo 2 mt./Suspension kit with cable 2 mt.	13,88
60086	Nero/Black	Staffa soffitto/Ceiling bracket	4,32
60087	Bianco/White	Staffa soffitto/Ceiling bracket	4,32
60079	Nero/Black	Giunto "+"/"+" connector	37,95
60080	Bianco/White	Giunto "+"/"+" connector	37,95
60067	Nero/Black	Giunto-1 "T"/"T"connector-1	31,91
60068	Bianco/White	Giunto-1 "T"/"T"connector-1	31,91
60070	Nero/Black	Giunto-2 "T"/"T"connector-2	31,91
60071	Bianco/White	Giunto-2 "T"/"T"connector-2	31,91
60073	Nero/Black	Giunto-3 "T"/"T"connector-3	31,91
60074	Bianco/White	Giunto-3 "T"/"T"connector-3	31,91
60076	Nero/Black	Giunto-4 "T"/"T"connector-4	31,91
60077	Bianco/White	Giunto-4 "T"/"T"connector-4	31,91
60061	Nero/Black	Giunto-1 "L"/"L"connector-1	22,41
60062	Bianco/White	Giunto-1 "L"/"L"connector-1	22,41
60064	Nero/Black	Giunto-2 "L"/"L"connector-2	22,41
60065	Bianco/White	Giunto-2 "L"/"L"connector-2	22,41
60058	Nero/Black	Congiunzione/ straight connector	6,87
60059	Bianco/White	Congiunzione/ straight connector	6,87
52582/N	Nero/Black	Adattatore binario/track adaptor	10,69
52582/B	Bianco/White	Adattatore binario/track adaptor	10,69
11621	Nero/Black	Accessorio soffitto per Euro-track / Euro-track ceiling accessory	20,89
11620	Bianco/White	Accessorio soffitto per Euro-track / Euro-track ceiling accessory	20,89

ACCESSORI ACCESSORIES

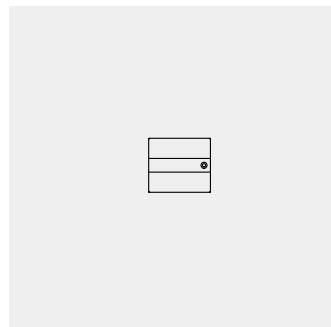

60104 - 60105

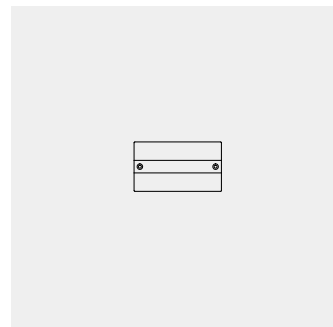

60106 - 60107

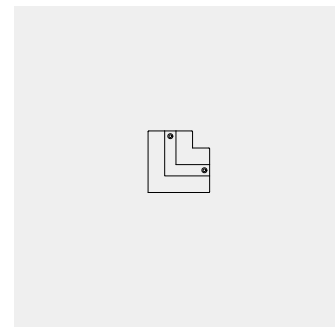

60108 - 60109

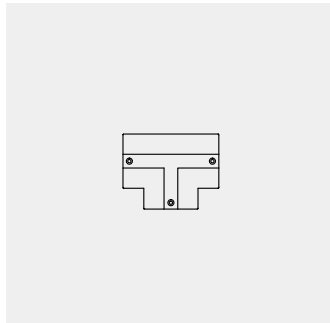

60110 - 60111

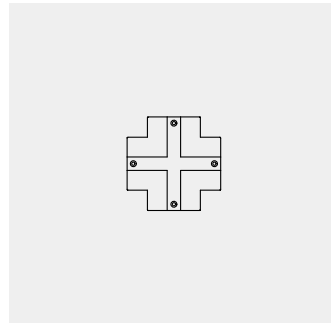

60112 - 60113

CODE	FINISHING	DESCRIPTION	PRICE
60104	Nero/Black	Copertura alim. sx/dx binario incasso/ Right/left feed cover	2,13
60105	Bianco/White	Copertura alim. sx/dx binario incasso/ Right/left feed cover	2,13
60106	Nero/Black	Copertura alim. centrale binario incasso/ Middle feed cover	2,74
60107	Bianco/White	Copertura alim. centrale binario incasso/ Middle feed cover	2,74
60108	Nero/Black	Copertura giunto "L" binario incasso/ "L" connector cover	2,74
60109	Bianco/White	Copertura giunto "L" binario incasso/ "L" connector cover	2,74
60110	Nero/Black	Copertura giunto "T" binario incasso/ "T" connector cover	2,74
60111	Bianco/White	Copertura giunto "T" binario incasso/ "T" connector cover	2,74
60112	Nero/Black	Copertura giunto "+" binario incasso/ "+" connector cover	3,36
60113	Bianco/White	Copertura giunto "+" binario incasso/ "+" connector cover	3,36

EMERGENZA

Lampada emergenza 3W
per binari Autonomia 3 H
Emergency track lamp 3W
3 Hours autonomy



CODE	FINISHING	WATT	LUMEN	KELVIN	BEAM	KG	PRICE
60114	Nero/Black	3	150	3000K	30°	0,15	149,30
60115	Bianco/White	3	150	3000K	30°	0,15	149,30

INSTALLAZIONE
APPLICATION



Binario/Track

DISEGNI TECNICI
TECHNICAL DRAWINGS

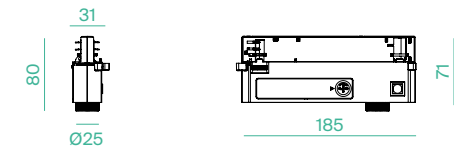

ACCESSORI ACCESSORIES

CODE	DESCRIPTION	PRICE
60116	Batteria Litio 18650 3,7V 2600mAH per cod.60114/60115 / Lithium battery 18650 3,7V 2600mAH for cod.60114/60115	15,90



DOT_30



LED SMD
CRI >90
PF 0,5
SDCM ≥3

CODE	FINISHING	WATT	LUMEN	WATT LIGHT SOURCE	LUMEN LIGHT SOURCE	BEAM	KELVIN	DRIVER	KG	PRICE
72043	Bianco/White	6W	365	4,5W	460	30°	2700K	9V/500mA	0,09	24,00
72044	Nero/Black	6W	365	4,5W	460	30°	2700K	9V/500mA	0,09	24,00
72045	Royal Gold	6W	365	4,5W	460	30°	2700K	9V/500mA	0,09	26,00
72046	Vintage Brass	6W	365	4,5W	460	30°	2700K	9V/500mA	0,09	26,00
72047	Bianco/White	6W	375	4,5W	480	30°	3000K	9V/500mA	0,09	24,00
72048	Nero/Black	6W	375	4,5W	480	30°	3000K	9V/500mA	0,09	24,00
72049	Royal Gold	6W	375	4,5W	480	30°	3000K	9V/500mA	0,09	26,00
72050	Vintage Brass	6W	375	4,5W	480	30°	3000K	9V/500mA	0,09	26,00

INSTALLAZIONE APPLICATION

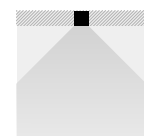

Incasso/Recessed

DISEGNI TECNICI TECHNICAL DRAWING

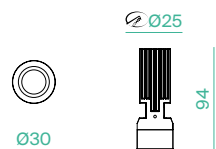

DRIVER

CODE	VOLT	CURRENT	SIZE	MODE	PRICE
72037	5-12V	500mA	84x20,5x16,5	ON/OFF	7,00
72040	2-12V	500mA	84x20x20	DIMM.	23,60

DOT_40

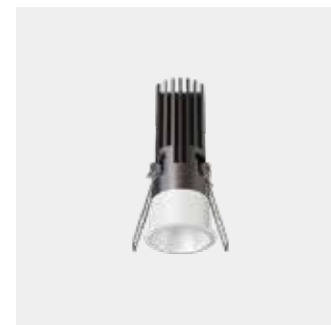

LED V4HD GEN8
CRI >90
PF 0,5
SDCM ≥3

CODE	FINISHING	WATT	LUMEN	WATT LIGHT SOURCE	LUMEN LIGHT SOURCE	BEAM	KELVIN	DRIVER	KG	PRICE
72051	Bianco/White	9W	550	7,5W	775	30°	2700K	36V/200mA	0,14	26,50
72052	Nero/Black	9W	550	7,5W	775	30°	2700K	36V/200mA	0,14	26,50
72053	Royal Gold	9W	550	7,5W	775	30°	2700K	36V/200mA	0,14	28,50
72054	Vintage Brass	9W	550	7,5W	775	30°	2700K	36V/200mA	0,14	28,50
72055	Bianco/White	9W	550	7,5W	775	40°	2700K	36V/200mA	0,14	26,50
72056	Nero/Black	9W	550	7,5W	775	40°	2700K	36V/200mA	0,14	26,50
72057	Royal Gold	9W	550	7,5W	775	40°	2700K	36V/200mA	0,14	28,50
72058	Vintage Brass	9W	550	7,5W	775	40°	2700K	36V/200mA	0,14	28,50
72059	Bianco/White	9W	590	7,5W	850	30°	3000K	36V/200mA	0,14	26,50
72060	Nero/Black	9W	590	7,5W	850	30°	3000K	36V/200mA	0,14	26,50
72061	Royal Gold	9W	590	7,5W	850	30°	3000K	36V/200mA	0,14	28,50
72062	Vintage Brass	9W	590	7,5W	850	30°	3000K	36V/200mA	0,14	28,50
72063	Bianco/White	9W	590	7,5W	850	40°	3000K	36V/200mA	0,14	26,50
72064	Nero/Black	9W	590	7,5W	850	40°	3000K	36V/200mA	0,14	26,50
72065	Royal Gold	9W	590	7,5W	850	40°	3000K	36V/200mA	0,14	28,50
72066	Vintage Brass	9W	590	7,5W	850	40°	3000K	36V/200mA	0,14	28,50

INSTALLAZIONE APPLICATION

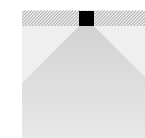

Incasso/Recessed

DISEGNI TECNICI TECHNICAL DRAWING

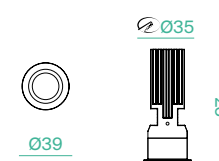

DRIVER

CODE	VOLT	CURRENT	SIZE	MODE	PRICE
72038	27-40V	200mA	84X20,5X16,5	ON/OFF	7,00
72041	9-42V	200mA	110x29,6x22,6	DIMM.	16,00

DOT_50



LED V6HD GEN8
CRI >90
PF 0,5
SDCM ≥3

CODE	FINISHING	WATT	LUMEN	WATT LIGHT SOURCE	LUMEN LIGHT SOURCE	BEAM	KELVIN	DRIVER	KG	PRICE
72067	Bianco/White	12W	935	10,7W	1280	30°	2700K	36V/300mA	0,22	30,00
72068	Nero/Black	12W	935	10,7W	1280	30°	2700K	36V/300mA	0,22	30,00
72069	Royal Gold	12W	935	10,7W	1280	30°	2700K	36V/300mA	0,22	32,00
72070	Vintage Brass	12W	935	10,7W	1280	30°	2700K	36V/300mA	0,22	32,00
72071	Bianco/White	12W	935	10,7W	1280	55°	2700K	36V/300mA	0,22	30,00
72072	Nero/Black	12W	935	10,7W	1280	55°	2700K	36V/300mA	0,22	30,00
72073	Royal Gold	12W	935	10,7W	1280	55°	2700K	36V/300mA	0,22	32,00
72074	Vintage Brass	12W	935	10,7W	1280	55°	2700K	36V/300mA	0,22	32,00
72075	Bianco/White	12W	965	10,7W	1305	30°	3000K	36V/300mA	0,22	30,00
72076	Nero/Black	12W	965	10,7W	1305	30°	3000K	36V/300mA	0,22	30,00
72077	Royal Gold	12W	965	10,7W	1305	30°	3000K	36V/300mA	0,22	32,00
72078	Vintage Brass	12W	965	10,7W	1305	30°	3000K	36V/300mA	0,22	32,00
72079	Bianco/White	12W	965	10,7W	1305	55°	3000K	36V/300mA	0,22	30,00
72080	Nero/Black	12W	965	10,7W	1305	55°	3000K	36V/300mA	0,22	30,00
72081	Royal Gold	12W	965	10,7W	1305	55°	3000K	36V/300mA	0,22	32,00
72082	Vintage Brass	12W	965	10,7W	1305	55°	3000K	36V/300mA	0,22	32,00

INSTALLAZIONE APPLICATION

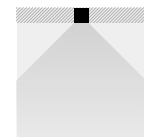

Incasso/Recessed

DISEGNI TECNICI TECHNICAL DRAWING

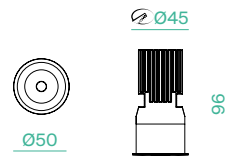

DRIVER

CODE	VOLT	CURRENT	SIZE	MODE	PRICE
72039	24-42V	300mA	100x38,2x20	ON/OFF	7,00
72042	9-40V	300mA	150,5x42,5x28,5	DIMM.	28,80



DEEP_EVO EXTR. 9W



LED V6HD
CRI 90
PF 0,56
SDCM <3
UGR <20

CODE	FINISHING	WATT	LUMEN	WATT LIGHT SOURCE	LUMEN LIGHT SOURCE	BEAM	KELVIN	DRIVER	MODE	KG	PRICE
71794	Bianco/White	9	645	7	835	15°	3000K	30-42V 200mA	ON-OFF	0,20	38,32
71795	Bianco/White	9	680	7	835	24°	3000K	30-42V 200mA	ON-OFF	0,20	38,32
71796	Bianco/White	9	685	7	835	38°	3000K	30-42V 200mA	ON-OFF	0,20	38,32
71797	Bianco/White	9	675	7	835	55°	3000K	30-42V 200mA	ON-OFF	0,20	38,32
71798	Nero/Black	9	645	7	835	15°	3000K	30-42V 200mA	ON-OFF	0,20	38,32
71799	Nero/Black	9	680	7	835	24°	3000K	30-42V 200mA	ON-OFF	0,20	38,32
71800	Nero/Black	9	685	7	835	38°	3000K	30-42V 200mA	ON-OFF	0,20	38,32
71801	Nero/Black	9	675	7	835	55°	3000K	30-42V 200mA	ON-OFF	0,20	38,32
71842	Bianco/White	9	645	7	835	15°	3000K	30-42V 200mA	1-10V	0,20	55,41
71843	Bianco/White	9	680	7	835	24°	3000K	30-42V 200mA	1-10V	0,20	55,41
71844	Bianco/White	9	685	7	835	38°	3000K	30-42V 200mA	1-10V	0,20	55,41
71845	Bianco/White	9	675	7	835	55°	3000K	30-42V 200mA	1-10V	0,20	55,41
71846	Nero/Black	9	645	7	835	15°	3000K	30-42V 200mA	1-10V	0,20	55,41
71847	Nero/Black	9	680	7	835	24°	3000K	30-42V 200mA	1-10V	0,20	55,41
71848	Nero/Black	9	685	7	835	38°	3000K	30-42V 200mA	1-10V	0,20	55,41
71849	Nero/Black	9	675	7	835	55°	3000K	30-42V 200mA	1-10V	0,20	55,41
71890	Bianco/White	9	675	7	835	15°	3000K	30-42V 200mA	DALI-PUSH	0,20	79,88
71891	Bianco/White	9	675	7	835	24°	3000K	30-42V 200mA	DALI-PUSH	0,20	79,88
71892	Bianco/White	9	675	7	835	38°	3000K	30-42V 200mA	DALI-PUSH	0,20	79,88
71893	Bianco/White	9	675	7	835	55°	3000K	30-42V 200mA	DALI-PUSH	0,20	79,88
71894	Nero/Black	9	675	7	835	15°	3000K	30-42V 200mA	DALI-PUSH	0,20	79,88
71895	Nero/Black	9	675	7	835	24°	3000K	30-42V 200mA	DALI-PUSH	0,20	79,88
71896	Nero/Black	9	675	7	835	38°	3000K	30-42V 200mA	DALI-PUSH	0,20	79,88
71897	Nero/Black	9	675	7	835	55°	3000K	30-42V 200mA	DALI-PUSH	0,20	79,88

INSTALLAZIONE APPLICATION

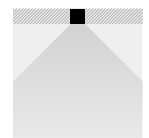

Incasso/Recessed

DISEGNI TECNICI TECHNICAL DRAWINGS

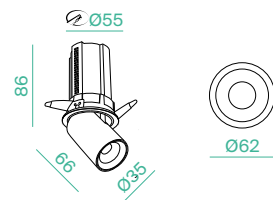

REGOLAZIONI ADJUSTABILITY



DEEP_EVO_LESS EXTR. 9W



LED V6HD
CRI 90
PF 0,56
SDCM <3
UGR <23

CODE	FINISHING	WATT	LUMEN	WATT LIGHT SOURCE	LUMEN LIGHT SOURCE	BEAM	KELVIN	DRIVER	MODE	KG	PRICE
71818	Bianco/White	9	645	7	835	15°	3000K	30-42V 200mA	ON-OFF	0,20	43,40
71819	Bianco/White	9	680	7	835	24°	3000K	30-42V 200mA	ON-OFF	0,20	43,40
71820	Bianco/White	9	685	7	835	38°	3000K	30-42V 200mA	ON-OFF	0,20	43,40
71821	Bianco/White	9	675	7	835	55°	3000K	30-42V 200mA	ON-OFF	0,20	43,40
71822	Nero/Black	9	645	7	835	15°	3000K	30-42V 200mA	ON-OFF	0,20	43,40
71823	Nero/Black	9	680	7	835	24°	3000K	30-42V 200mA	ON-OFF	0,20	43,40
71824	Nero/Black	9	685	7	835	38°	3000K	30-42V 200mA	ON-OFF	0,20	43,40
71825	Nero/Black	9	675	7	835	55°	3000K	30-42V 200mA	ON-OFF	0,20	43,40
71866	Bianco/White	9	645	7	835	15°	3000K	30-42V 200mA	1-10V	0,20	60,50
71867	Bianco/White	9	680	7	835	24°	3000K	30-42V 200mA	1-10V	0,20	60,50
71868	Bianco/White	9	685	7	835	38°	3000K	30-42V 200mA	1-10V	0,20	60,50
71869	Bianco/White	9	675	7	835	55°	3000K	30-42V 200mA	1-10V	0,20	60,50
71870	Nero/Black	9	645	7	835	15°	3000K	30-42V 200mA	1-10V	0,20	60,50
71871	Nero/Black	9	680	7	835	24°	3000K	30-42V 200mA	1-10V	0,20	60,50
71872	Nero/Black	9	685	7	835	38°	3000K	30-42V 200mA	1-10V	0,20	60,50
71873	Nero/Black	9	675	7	835	55°	3000K	30-42V 200mA	1-10V	0,20	60,50
71914	Bianco/White	9	675	7	835	15°	3000K	30-42V 200mA	DALI-PUSH	0,20	84,96
71915	Bianco/White	9	675	7	835	24°	3000K	30-42V 200mA	DALI-PUSH	0,20	84,96
71916	Bianco/White	9	675	7	835	38°	3000K	30-42V 200mA	DALI-PUSH	0,20	84,96
71917	Bianco/White	9	675	7	835	55°	3000K	30-42V 200mA	DALI-PUSH	0,20	84,96
71918	Nero/Black	9	675	7	835	15°	3000K	30-42V 200mA	DALI-PUSH	0,20	84,96
71919	Nero/Black	9	675	7	835	24°	3000K	30-42V 200mA	DALI-PUSH	0,20	84,96
71920	Nero/Black	9	675	7	835	38°	3000K	30-42V 200mA	DALI-PUSH	0,20	84,96
71921	Nero/Black	9	675	7	835	55°	3000K	30-42V 200mA	DALI-PUSH	0,20	84,96

INSTALLAZIONE APPLICATION



Incasso/Recessed

DISEGNI TECNICI TECHNICAL DRAWINGS

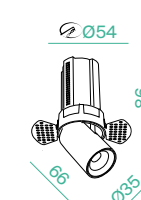

REGOLAZIONI ADJUSTABILITY



DEEP_EVO EXTR. 12W



LED V6HD
CRI 90
PF 0,94
SDCM <3
UGR <20

CODE	FINISHING	WATT	LUMEN	WATT LIGHT SOURCE	LUMEN LIGHT SOURCE	BEAM	KELVIN	DRIVER	MODE	KG	PRICE
71802	Bianco/White	12	940	10,8	1151	15°	3000K	30-42V 300mA	ON-OFF	0,32	49,34
71803	Bianco/White	12	1040	10,8	1151	24°	3000K	30-42V 300mA	ON-OFF	0,32	49,34
71804	Bianco/White	12	1000	10,8	1151	38°	3000K	30-42V 300mA	ON-OFF	0,32	49,34
71805	Bianco/White	12	990	10,8	1151	55°	3000K	30-42V 300mA	ON-OFF	0,32	49,34
71806	Nero/Black	12	940	10,8	1151	15°	3000K	30-42V 300mA	ON-OFF	0,32	49,34
71807	Nero/Black	12	1040	10,8	1151	24°	3000K	30-42V 300mA	ON-OFF	0,32	49,34
71808	Nero/Black	12	1000	10,8	1151	38°	3000K	30-42V 300mA	ON-OFF	0,32	49,34
71809	Nero/Black	12	990	10,8	1151	55°	3000K	30-42V 300mA	ON-OFF	0,32	49,34
71850	Bianco/White	12	940	10,8	1151	15°	3000K	30-42V 300mA	1-10V	0,32	71,22
71851	Bianco/White	12	1040	10,8	1151	24°	3000K	30-42V 300mA	1-10V	0,32	71,22
71852	Bianco/White	12	1000	10,8	1151	38°	3000K	30-42V 300mA	1-10V	0,32	71,22
71853	Bianco/White	12	990	10,8	1151	55°	3000K	30-42V 300mA	1-10V	0,32	71,22
71854	Nero/Black	12	940	10,8	1151	15°	3000K	30-42V 300mA	1-10V	0,32	71,22
71855	Nero/Black	12	1040	10,8	1151	24°	3000K	30-42V 300mA	1-10V	0,32	71,22
71856	Nero/Black	12	1000	10,8	1151	38°	3000K	30-42V 300mA	1-10V	0,32	71,22
71857	Nero/Black	12	990	10,8	1151	55°	3000K	30-42V 300mA	1-10V	0,32	71,22
71898	Bianco/White	12	940	10,8	1151	15°	3000K	30-42V 300mA	DALI-PUSH	0,32	89,76
71899	Bianco/White	12	1040	10,8	1151	24°	3000K	30-42V 300mA	DALI-PUSH	0,32	89,76
71900	Bianco/White	12	1000	10,8	1151	38°	3000K	30-42V 300mA	DALI-PUSH	0,32	89,76
71901	Bianco/White	12	990	10,8	1151	55°	3000K	30-42V 300mA	DALI-PUSH	0,32	89,76
71902	Nero/Black	12	940	10,8	1151	15°	3000K	30-42V 300mA	DALI-PUSH	0,32	89,76
71903	Nero/Black	12	1040	10,8	1151	24°	3000K	30-42V 300mA	DALI-PUSH	0,32	89,76
71904	Nero/Black	12	1000	10,8	1151	38°	3000K	30-42V 300mA	DALI-PUSH	0,32	89,76
71905	Nero/Black	12	990	10,8	1151	55°	3000K	30-42V 300mA	DALI-PUSH	0,32	89,76

INSTALLAZIONE APPLICATION

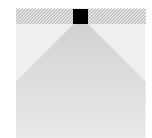

Incasso/Recessed

DISEGNI TECNICI TECHNICAL DRAWINGS

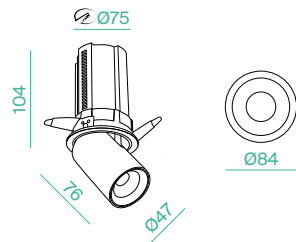

REGOLAZIONI ADJUSTABILITY



DEEP_EVO_LESS EXTR. 12W



LED V6HD
CRI 90
PF 0,94
SDCM <3
UGR <20

CODE	FINISHING	WATT	LUMEN	WATT LIGHT SOURCE	LUMEN LIGHT SOURCE	BEAM	KELVIN	DRIVER	MODE	KG	PRICE
71826	Bianco/White	12	940	10,8	1151	15°	3000K	30-42V 300mA	ON-OFF	0,32	55,18
71827	Bianco/White	12	1040	10,8	1151	24°	3000K	30-42V 300mA	ON-OFF	0,32	55,18
71828	Bianco/White	12	1000	10,8	1151	38°	3000K	30-42V 300mA	ON-OFF	0,32	55,18
71829	Bianco/White	12	990	10,8	1151	55°	3000K	30-42V 300mA	ON-OFF	0,32	55,18
71830	Nero/Black	12	940	10,8	1151	15°	3000K	30-42V 300mA	ON-OFF	0,32	55,18
71831	Nero/Black	12	1040	10,8	1151	24°	3000K	30-42V 300mA	ON-OFF	0,32	55,18
71832	Nero/Black	12	1000	10,8	1151	38°	3000K	30-42V 300mA	ON-OFF	0,32	55,18
71833	Nero/Black	12	990	10,8	1151	55°	3000K	30-42V 300mA	ON-OFF	0,32	55,18
71874	Bianco/White	12	940	10,8	1151	15°	3000K	30-42V 300mA	1-10V	0,32	77,06
71875	Bianco/White	12	1040	10,8	1151	24°	3000K	30-42V 300mA	1-10V	0,32	77,06
71876	Bianco/White	12	1000	10,8	1151	38°	3000K	30-42V 300mA	1-10V	0,32	77,06
71877	Bianco/White	12	990	10,8	1151	55°	3000K	30-42V 300mA	1-10V	0,32	77,06
71878	Nero/Black	12	940	10,8	1151	15°	3000K	30-42V 300mA	1-10V	0,32	77,06
71879	Nero/Black	12	1040	10,8	1151	24°	3000K	30-42V 300mA	1-10V	0,32	77,06
71880	Nero/Black	12	1000	10,8	1151	38°	3000K	30-42V 300mA	1-10V	0,32	77,06
71881	Nero/Black	12	990	10,8	1151	55°	3000K	30-42V 300mA	1-10V	0,32	77,06
71922	Bianco/White	12	940	10,8	1151	15°	3000K	30-42V 300mA	DALI-PUSH	0,32	95,60
71923	Bianco/White	12	1040	10,8	1151	24°	3000K	30-42V 300mA	DALI-PUSH	0,32	95,60
71924	Bianco/White	12	1000	10,8	1151	38°	3000K	30-42V 300mA	DALI-PUSH	0,32	95,60
71925	Bianco/White	12	990	10,8	1151	55°	3000K	30-42V 300mA	DALI-PUSH	0,32	95,60
71926	Nero/Black	12	940	10,8	1151	15°	3000K	30-42V 300mA	DALI-PUSH	0,32	95,60
71927	Nero/Black	12	1040	10,8	1151	24°	3000K	30-42V 300mA	DALI-PUSH	0,32	95,60
71928	Nero/Black	12	1000	10,8	1151	38°	3000K	30-42V 300mA	DALI-PUSH	0,32	95,60
71929	Nero/Black	12	990	10,8	1151	55°	3000K	30-42V 300mA	DALI-PUSH	0,32	95,60

INSTALLAZIONE APPLICATION

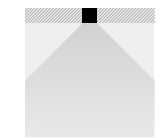

Incasso/Recessed

DISEGNI TECNICI TECHNICAL DRAWINGS

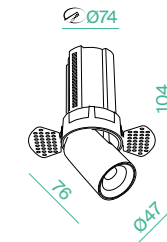

REGOLAZIONI ADJUSTABILITY



DEEP_EVO EXTR. 15W



LED V6HD
CRI 90
PF 0,95
SDCM <3
UGR <20

CODE	FINISHING	WATT	LUMEN	WATT LIGHT SOURCE	LUMEN LIGHT SOURCE	BEAM	KELVIN	DRIVER	MODE	KG	PRICE
71810	Bianco/White	15	1040	12,8	1286	15°	3000K	30-42V 350mA	ON-OFF	0,62	63,60
71811	Bianco/White	15	1145	12,8	1286	24°	3000K	30-42V 350mA	ON-OFF	0,62	63,60
71812	Bianco/White	15	1099	12,8	1286	38°	3000K	30-42V 350mA	ON-OFF	0,62	63,60
71813	Bianco/White	15	1005	12,8	1286	55°	3000K	30-42V 350mA	ON-OFF	0,62	63,60
71814	Nero/Black	15	1040	12,8	1286	15°	3000K	30-42V 350mA	ON-OFF	0,62	63,60
71815	Nero/Black	15	1145	12,8	1286	24°	3000K	30-42V 350mA	ON-OFF	0,62	63,60
71816	Nero/Black	15	1099	12,8	1286	38°	3000K	30-42V 350mA	ON-OFF	0,62	63,60
71817	Nero/Black	15	1005	12,8	1286	55°	3000K	30-42V 350mA	ON-OFF	0,62	63,60
71858	Bianco/White	15	1040	12,8	1286	15°	3000K	30-42V 350mA	1-10V	0,62	88,84
71859	Bianco/White	15	1145	12,8	1286	24°	3000K	30-42V 350mA	1-10V	0,62	88,84
71860	Bianco/White	15	1099	12,8	1286	38°	3000K	30-42V 350mA	1-10V	0,62	88,84
71861	Bianco/White	15	1005	12,8	1286	55°	3000K	30-42V 350mA	1-10V	0,62	88,84
71862	Nero/Black	15	1040	12,8	1286	15°	3000K	30-42V 350mA	1-10V	0,62	88,84
71863	Nero/Black	15	1145	12,8	1286	24°	3000K	30-42V 350mA	1-10V	0,62	88,84
71864	Nero/Black	15	1099	12,8	1286	38°	3000K	30-42V 350mA	1-10V	0,62	88,84
71865	Nero/Black	15	1005	12,8	1286	55°	3000K	30-42V 350mA	1-10V	0,62	88,84
71906	Bianco/White	15	1040	12,8	1286	15°	3000K	30-42V 350mA	DALI-PUSH	0,62	106,86
71907	Bianco/White	15	1145	12,8	1286	24°	3000K	30-42V 350mA	DALI-PUSH	0,62	106,86
71908	Bianco/White	15	1099	12,8	1286	38°	3000K	30-42V 350mA	DALI-PUSH	0,62	106,86
71909	Bianco/White	15	1005	12,8	1286	55°	3000K	30-42V 350mA	DALI-PUSH	0,62	106,86
71910	Nero/Black	15	1040	12,8	1286	15°	3000K	30-42V 350mA	DALI-PUSH	0,62	106,86
71911	Nero/Black	15	1145	12,8	1286	24°	3000K	30-42V 350mA	DALI-PUSH	0,62	106,86
71912	Nero/Black	15	1099	12,8	1286	38°	3000K	30-42V 350mA	DALI-PUSH	0,62	106,86
71913	Nero/Black	15	1005	12,8	1286	55°	3000K	30-42V 350mA	DALI-PUSH	0,62	106,86

INSTALLAZIONE APPLICATION

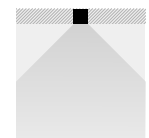

Incasso/Recessed

DISEGNI TECNICI TECHNICAL DRAWINGS

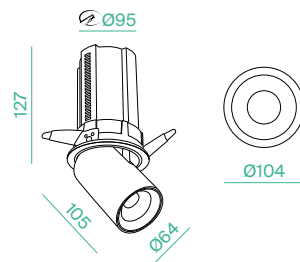

REGOLAZIONI ADJUSTABILITY



355°
90°



DEEP_EVO_LESS EXTR. 15W



LED V6HD
CRI 90
PF 0,96
SDCM <3
UGR <20

CODE	FINISHING	WATT	LUMEN	WATT LIGHT SOURCE	LUMEN LIGHT SOURCE	BEAM	KELVIN	DRIVER	MODE	KG	PRICE
71834	Bianco/White	15	1040	12,8	1286	15°	3000K	30-42V 350mA	ON-OFF	0,62	70,25
71835	Bianco/White	15	1145	12,8	1286	24°	3000K	30-42V 350mA	ON-OFF	0,62	70,25
71836	Bianco/White	15	1099	12,8	1286	38°	3000K	30-42V 350mA	ON-OFF	0,62	70,25
71837	Bianco/White	15	1005	12,8	1286	55°	3000K	30-42V 350mA	ON-OFF	0,62	70,25
71838	Nero/Black	15	1040	12,8	1286	15°	3000K	30-42V 350mA	ON-OFF	0,62	70,25
71839	Nero/Black	15	1145	12,8	1286	24°	3000K	30-42V 350mA	ON-OFF	0,62	70,25
71840	Nero/Black	15	1099	12,8	1286	38°	3000K	30-42V 350mA	ON-OFF	0,62	70,25
71841	Nero/Black	15	1005	12,8	1286	55°	3000K	30-42V 350mA	ON-OFF	0,62	70,25
71882	Bianco/White	15	1040	12,8	1286	15°	3000K	30-42V 350mA	1-10V	0,62	95,24
71883	Bianco/White	15	1145	12,8	1286	24°	3000K	30-42V 350mA	1-10V	0,62	95,24
71884	Bianco/White	15	1099	12,8	1286	38°	3000K	30-42V 350mA	1-10V	0,62	95,24
71885	Bianco/White	15	1005	12,8	1286	55°	3000K	30-42V 350mA	1-10V	0,62	95,24
71886	Nero/Black	15	1040	12,8	1286	15°	3000K	30-42V 350mA	1-10V	0,62	95,24
71887	Nero/Black	15	1145	12,8	1286	24°	3000K	30-42V 350mA	1-10V	0,62	95,24
71888	Nero/Black	15	1099	12,8	1286	38°	3000K	30-42V 350mA	1-10V	0,62	95,24
71889	Nero/Black	15	1005	12,8	1286	55°	3000K	30-42V 350mA	1-10V	0,62	95,24
71930	Bianco/White	15	1040	12,8	1286	15°	3000K	30-42V 350mA	DALI-PUSH	0,62	113,27
71931	Bianco/White	15	1145	12,8	1286	24°	3000K	30-42V 350mA	DALI-PUSH	0,62	113,27
71932	Bianco/White	15	1099	12,8	1286	38°	3000K	30-42V 350mA	DALI-PUSH	0,62	113,27
71933	Bianco/White	15	1005	12,8	1286	55°	3000K	30-42V 350mA	DALI-PUSH	0,62	113,27
71934	Nero/Black	15	1040	12,8	1286	15°	3000K	30-42V 350mA	DALI-PUSH	0,62	113,27
71935	Nero/Black	15	1145	12,8	1286	24°	3000K	30-42V 350mA	DALI-PUSH	0,62	113,27
71936	Nero/Black	15	1099	12,8	1286	38°	3000K	30-42V 350mA	DALI-PUSH	0,62	113,27
71937	Nero/Black	15	1005	12,8	1286	55°	3000K	30-42V 350mA	DALI-PUSH	0,62	113,27

INSTALLAZIONE APPLICATION

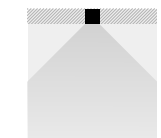

Incasso/Recessed

DISEGNI TECNICI TECHNICAL DRAWINGS

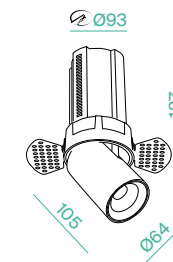

REGOLAZIONI ADJUSTABILITY



355°
90°



DEEP_EVO FIX



CODE	BODY FINISHING	FINISHING REFLECTOR	MODULI	KG	PRICE
71582	Bianco/White	Bianco/White	Pag. 68-69	0,12	16,38
71583	Bianco/White	Nero/Black	Pag. 68-69	0,12	16,38
71585	Nero/Black	Bianco/White	Pag. 68-69	0,12	16,38
71586	Nero/Black	Nero/Black	Pag. 68-69	0,12	16,38

DEEP_EVO ADJUSTABLE



CODE	BODY FINISHING	FINISHING REFLECTOR	MODULI	KG	PRICE
71588	Bianco/White	Bianco/White	Pag. 68-69	0,12	16,38
71589	Bianco/White	Nero/Black	Pag. 68-69	0,12	16,38
71591	Nero/Black	Bianco/White	Pag. 68-69	0,12	16,38
71592	Nero/Black	Nero/Black	Pag. 68-69	0,12	16,38

REGOLAZIONI
ADJUSTABILITY



INSTALLAZIONE
APPLICATION

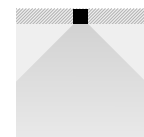

Incasso/Recessed

DISEGNI TECNICI C/ MODULO LED
TECHNICAL DRAWING W/ LED MODULE

LED Module 9W

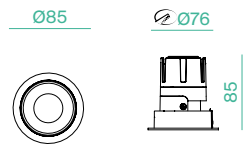

LED Module 12W-15W

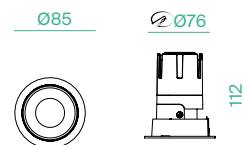

DEEP_EVO LESS FIX



CODE	BODY FINISHING	FINISHING REFLECTOR	MODULI	KG	PRICE
71594	Bianco/White	Bianco/White	Pag. 68-69	0,13	24,13
71595	Bianco/White	Nero/Black	Pag. 68-69	0,13	24,13

DEEP_EVO LESS ADJUSTABLE



CODE	BODY FINISHING	FINISHING REFLECTOR	MODULI	KG	PRICE
71597	Bianco/White	Bianco/White	Pag. 68-69	0,13	24,13
71598	Bianco/White	Nero/Black	Pag. 68-69	0,13	24,13

REGOLAZIONI
ADJUSTABILITY



INSTALLAZIONE
APPLICATION



Incasso/Recessed

DISEGNI TECNICI C/ MODULO LED
TECHNICAL DRAWING W/ LED MODULE

LED Module 9W

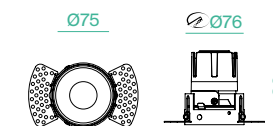

LED Module 12W-15W

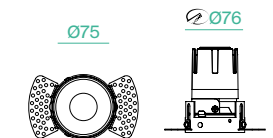

DEEP_EVO
GRANDE
FIX



CODE	BODY FINISHING	FINISHING REFLECTOR	MODULI	KG	PRICE
71729	Bianco/White	Bianco/White	Pag. 68-69	0,22	30,59
71730	Bianco/White	Nero/Black	Pag. 68-69	0,22	30,59
71732	Nero/Black	Bianco/White	Pag. 68-69	0,22	30,59
71733	Nero/Black	Nero/Black	Pag. 68-69	0,22	30,59

DEEP_EVO
GRANDE
ADJUSTABLE



CODE	BODY FINISHING	FINISHING REFLECTOR	MODULI	KG	PRICE
71735	Bianco/White	Bianco/White	Pag. 68-69	0,22	30,59
71736	Bianco/White	Nero/Black	Pag. 68-69	0,22	30,59
71738	Nero/Black	Bianco/White	Pag. 68-69	0,22	30,59
71739	Nero/Black	Nero/Black	Pag. 68-69	0,22	30,59

REGOLAZIONI
ADJUSTABILITY



INSTALLAZIONE
APPLICATION

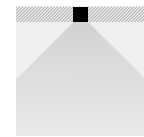

Incasso/Recessed

DISEGNI TECNICI C/ MODULO LED
TECHNICAL DRAWING W/ LED MODULE

LED Module 20W-24W

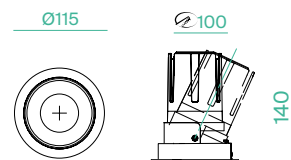

DEEP_EVO
LESS_GRANDE
FIX



CODE	BODY FINISHING	FINISHING REFLECTOR	MODULI	KG	PRICE
71741	Bianco/White	Bianco/White	Pag. 68-69	0,24	41,10
71742	Bianco/White	Nero/Black	Pag. 68-69	0,24	41,10

DEEP_EVO
LESS_GRANDE
ADJUSTABLE



CODE	BODY FINISHING	FINISHING REFLECTOR	MODULI	KG	PRICE
71744	Bianco/White	Bianco/White	Pag. 68-69	0,24	41,10
71745	Bianco/White	Nero/Black	Pag. 68-69	0,24	41,10

REGOLAZIONI
ADJUSTABILITY



INSTALLAZIONE
APPLICATION

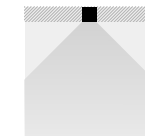

Incasso/Recessed

DISEGNI TECNICI C/ MODULO LED
TECHNICAL DRAWING W/ LED MODULE

LED Module 20W-24W

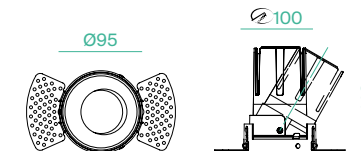

DEEP_EVO_Q FIX/ADJ



CODE	BODY FINISHING	FINISHING REFLECTOR	MODULI	KG	PRICE
71705	Bianco/White	Bianco/White	Pag. 68-69	0,13	16,38
71706	Bianco/White	Nero/Black	Pag. 68-69	0,13	16,38
71708	Nero/Black	Bianco/White	Pag. 68-69	0,13	16,38
71709	Nero/Black	Nero/Black	Pag. 68-69	0,13	16,38

REGOLAZIONI
ADJUSTABILITY



INSTALLAZIONE
APPLICATION

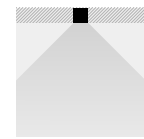

Incasso/Recessed

DISEGNI TECNICI C/ MODULO LED
TECHNICAL DRAWING W/ LED MODULE

LED Module 9W

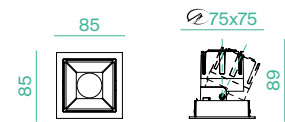

LED Module 12W-15W

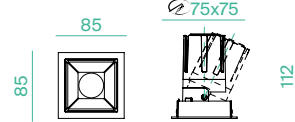

DEEP_EVO LESS_Q FIX/ADJ



CODE	BODY FINISHING	FINISHING REFLECTOR	MODULI	KG	PRICE
71711	Bianco/White	Bianco/White	Pag. 68-69	0,14	24,13
71712	Bianco/White	Nero/Black	Pag. 68-69	0,14	24,13

REGOLAZIONI
ADJUSTABILITY



INSTALLAZIONE
APPLICATION

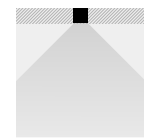

Incasso/Recessed

DISEGNI TECNICI C/ MODULO LED
TECHNICAL DRAWING W/ LED MODULE

LED Module 9W

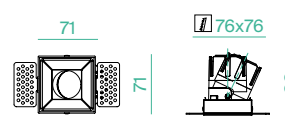

LED Module 12W-15W

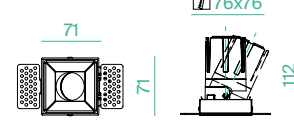

DEEP_EVO_Q GRANDE FIX/ADJ



CODE	BODY FINISHING	FINISHING REFLECTOR	MODULI	KG	PRICE
71723	Bianco/White	Bianco/White	Pag. 68-69	0,24	30,59
71724	Bianco/White	Nero/Black	Pag. 68-69	0,24	30,59
71726	Nero/Black	Bianco/White	Pag. 68-69	0,24	30,59
71727	Nero/Black	Nero/Black	Pag. 68-69	0,24	30,59

REGOLAZIONI
ADJUSTABILITY



INSTALLAZIONE
APPLICATION

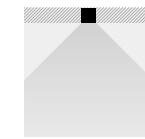

Incasso/Recessed

DISEGNI TECNICI C/ MODULO LED
TECHNICAL DRAWING W/ LED MODULE

LED Module 20W-24W

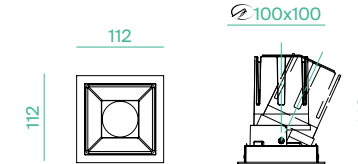

DEEP_EVO STD



CODE	BODY FINISHING	FINISHING REFLECTOR	MODULI	KG	PRICE
71600	Bianco/White	Bianco/White	Pag. 68-69	0,08	12,52
71601	Bianco/White	Nero/Black	Pag. 68-69	0,08	12,52
71603	Nero/Black	Bianco/White	Pag. 68-69	0,08	12,52
71604	Nero/Black	Nero/Black	Pag. 68-69	0,08	12,52

INSTALLAZIONE
APPLICATION

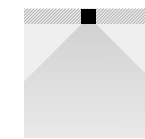

Incasso/Recessed

DISEGNI TECNICI C/ MODULO LED
TECHNICAL DRAWING W/ LED MODULE

LED Module 9W

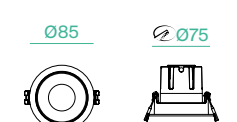

LED Module 12W-15W

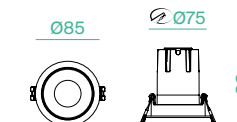

MODULO LED DEEP_EVO



LED BRIDGELUX
CRI >90
PF >0,9

CODE	WATT	LUMEN	BEAM	KELVIN	DRIVER	MODE	KG	PRICE
DEEP_EVO								
71606	9W	715	15°	3000K	30-42V 200mA	ON-OFF	0,16	29,87
71607	9W	725	24°	3000K	30-42V 200mA	ON-OFF	0,16	29,87
71608	9W	710	38°	3000K	30-42V 200mA	ON-OFF	0,16	29,87
71609	9W	695	55°	3000K	30-42V 200mA	ON-OFF	0,16	29,87
71610	12W	1015	15°	3000K	30-42V 300mA	ON-OFF	0,23	30,90
71611	12W	1055	24°	3000K	30-42V 300mA	ON-OFF	0,23	30,90
71612	12W	1050	38°	3000K	30-42V 300mA	ON-OFF	0,23	30,90
71613	12W	1000	55°	3000K	30-42V 300mA	ON-OFF	0,23	30,90
71614	15W	1150	15°	3000K	30-42V 350mA	ON-OFF	0,23	31,93
71615	15W	1170	24°	3000K	30-42V 350mA	ON-OFF	0,23	31,93
71616	15W	1155	38°	3000K	30-42V 350mA	ON-OFF	0,23	31,93
71617	15W	1110	55°	3000K	30-42V 350mA	ON-OFF	0,23	31,93
DEEP_EVO GRANDE								
71747	20W	1863	15°	3000K	40V 500mA	ON-OFF	0,34	41,49
71748	20W	1948	24°	3000K	40V 500mA	ON-OFF	0,34	41,49
71749	20W	1909	38°	3000K	40V 500mA	ON-OFF	0,34	41,49
71750	20W	1873	55°	3000K	40V 500mA	ON-OFF	0,34	41,49
71751	24W	2321	15°	3000K	40V 600mA	ON-OFF	0,34	42,18
71752	24W	2314	24°	3000K	40V 600mA	ON-OFF	0,34	42,18
71753	24W	2307	38°	3000K	40V 600mA	ON-OFF	0,34	42,18
71754	24W	2301	55°	3000K	40V 600mA	ON-OFF	0,34	42,18
DEEP_EVO								
71618	9W	715	15°	3000K	30-42V 200mA	1-10V	0,16	46,61
71619	9W	725	24°	3000K	30-42V 200mA	1-10V	0,16	46,61
71620	9W	710	38°	3000K	30-42V 200mA	1-10V	0,16	46,61
71621	9W	695	55°	3000K	30-42V 200mA	1-10V	0,16	46,61
71622	12W	1015	15°	3000K	30-42V 300mA	1-10V	0,23	52,53
71623	12W	1055	24°	3000K	30-42V 300mA	1-10V	0,23	52,53
71624	12W	1050	38°	3000K	30-42V 300mA	1-10V	0,23	52,53
71625	12W	1000	55°	3000K	30-42V 300mA	1-10V	0,23	52,53
71626	15W	1150	15°	3000K	30-42V 350mA	1-10V	0,23	57,17
71627	15W	1170	24°	3000K	30-42V 350mA	1-10V	0,23	57,17

CODE	WATT	LUMEN	BEAM	KELVIN	DRIVER	MODE	KG	PRICE
71628	15W	1155	38°	3000K	30-42V 350mA	1-10V	0,23	57,17
71629	15W	1110	55°	3000K	30-42V 350mA	1-10V	0,23	57,17
71763	9W	715	15°	3000K	30-42V 200mA	DALI/PUSH	0,16	71,07
71764	9W	725	24°	3000K	30-42V 200mA	DALI/PUSH	0,16	71,07
71765	9W	710	38°	3000K	30-42V 200mA	DALI/PUSH	0,16	71,07
71766	9W	695	55°	3000K	30-42V 200mA	DALI/PUSH	0,16	71,07
71767	12W	1015	15°	3000K	30-42V 300mA	DALI/PUSH	0,23	71,33
71768	12W	1055	24°	3000K	30-42V 300mA	DALI/PUSH	0,23	71,33
71769	12W	1050	38°	3000K	30-42V 300mA	DALI/PUSH	0,23	71,33
71770	12W	1000	55°	3000K	30-42V 300mA	DALI/PUSH	0,23	71,33
71771	15W	1150	15°	3000K	30-42V 350mA	DALI/PUSH	0,23	75,19
71772	15W	1170	24°	3000K	30-42V 350mA	DALI/PUSH	0,23	75,19
71773	15W	1155	38°	3000K	30-42V 350mA	DALI/PUSH	0,23	75,19
71774	15W	1110	55°	3000K	30-42V 350mA	DALI/PUSH	0,23	75,19
DEEP_EVO GRANDE								
71755	20W	1863	15°	3000K	40V 500mA	DALI/PUSH	0,34	83,43
71756	20W	1948	24°	3000K	40V 500mA	DALI/PUSH	0,34	83,43
71757	20W	1909	38°	3000K	40V 500mA	DALI/PUSH	0,34	83,43
71758	20W	1873	55°	3000K	40V 500mA	DALI/PUSH	0,34	83,43
71759	24W	2321	15°	3000K	40V 600mA	DALI/PUSH	0,34	86,01
71760	24W	2314	24°	3000K	40V 600mA	DALI/PUSH	0,34	86,01
71761	24W	2307	38°	3000K	40V 600mA	DALI/PUSH	0,34	86,01
71762	24W	2301	55°	3000K	40V 600mA	DALI/PUSH	0,34	86,01



ACCESSORI ACCESSORIES



CODE	DESCRIPTION	PRICE
71575	Filtro honeycomb 9W-12W-15W/ Honeycomb filter 9W-12W-15W	4,85
71663	Filtro honeycomb 20W-24W /Honeycomb filter 20W-24W	5,46

DEEP_EVO_GU10 FIX



CODE	BODY FINISHING	BASE	WATT	VOLT	KG	PRICE
71696	Bianco/White	GU10	Max 50W	230V 50/60Hz	0,12	18,20
71700	Nero/Black	GU10	Max 50W	230V 50/60Hz	0,12	18,20

INSTALLAZIONE APPLICATION

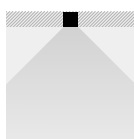

Incasso/Recessed

DISEGNI TECNICI TECHNICAL DRAWING

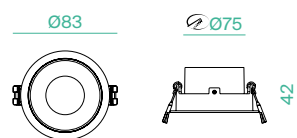

DEEP_EVO_GU10 ADJUSTABLE



CODE	BODY FINISHING	BASE	WATT	VOLT	KG	PRICE
71694	Bianco/White	GU10	Max 50W	230V 50/60Hz	0,12	18,20
71695	Nero/Black	GU10	Max 50W	230V 50/60Hz	0,12	18,20

INSTALLAZIONE APPLICATION

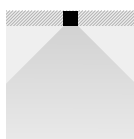

Incasso/Recessed

DISEGNI TECNICI TECHNICAL DRAWING

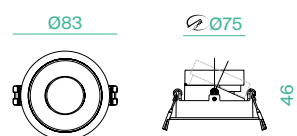

DEEP_EVO AR111 GU10 ADJUSTABLE

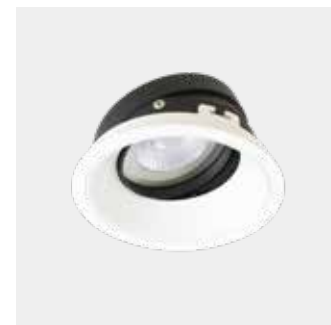

CODE	BODY FINISHING	BASE	WATT	VOLT	KG	PRICE
72083	Bianco/White	GU10	Max 50W	230V 50/60Hz	0,20	32,00
72084	Nero/Black	GU10	Max 50W	230V 50/60Hz	0,20	32,00

INSTALLAZIONE APPLICATION

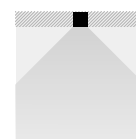

Incasso/Recessed

DISEGNI TECNICI TECHNICAL DRAWING

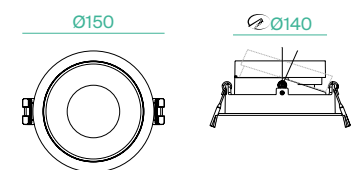

REGOLAZIONI ADJUSTABILITY



REGOLAZIONI ADJUSTABILITY



LIGHT_35



CODE	FINISHING	BASE	WATT	VOLT	KG	PRICE
41281	Bianco/White	GU10	Max 50W	230V 50/60Hz	0,090	13,70
41282	Nero/Black	GU10	Max 50W	230V 50/60Hz	0,090	13,70
41287	Oro/Gold	GU10	Max 50W	230V 50/60Hz	0,090	16,12

INSTALLAZIONE APPLICATION

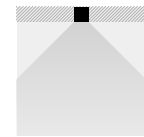

Incasso/Recessed

DISEGNI TECNICI TECHNICAL DRAWING

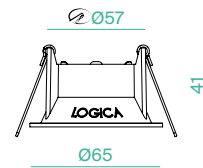

LIGHT_50



CODE	FINISHING	BASE	WATT	VOLT	KG	PRICE
41283	Bianco/White	GU10	Max 50W	230V 50/60Hz	0,120	15,71
41284	Nero/Black	GU10	Max 50W	230V 50/60Hz	0,120	15,71
41288	Oro/Gold	GU10	Max 50W	230V 50/60Hz	0,120	19,98

INSTALLAZIONE APPLICATION

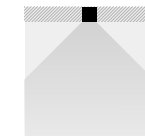

Incasso/Recessed

DISEGNI TECNICI TECHNICAL DRAWING

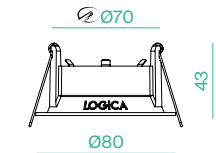

MODULE_PRECISE 35



LED BRIDGELUX
CRI >90
PF >0,8
SDCM 3

CODE	WATT	LUMEN 360°/CD	LUMEN 90°	BEAM	KELVIN	VOLT	MODE	KG	PRICE
21721	5,5W	470 / 1000	450	38°	2700K	220-240V	DIMM.	0,085	35,69
21722	5,5W	470 / 1000	450	38°	3000K	220-240V	DIMM.	0,085	35,69

DISEGNI TECNICI TECHNICAL DRAWING

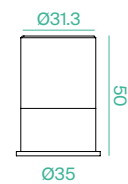

MODULE_PRECISE 50



LED BRIDGELUX
CRI >90
PF >0,8
SDCM 3

CODE	WATT	LUMEN 360°/CD	LUMEN 90°	BEAM	KELVIN	VOLT	MODE	KG	PRICE
21723	8,5W	740 / 4600	710	15°	2700K	220-240V	DIMM.	0,172	48,15
21724	8,5W	740 / 3690	710	24°	2700K	220-240V	DIMM.	0,172	48,15
21725	8,5W	740 / 1850	710	38°	2700K	220-240V	DIMM.	0,172	48,15
21726	8,5W	760 / 4750	730	15°	3000K	220-240V	DIMM.	0,172	48,15
21727	8,5W	760 / 3800	730	24°	3000K	220-240V	DIMM.	0,172	48,15
21728	8,5W	760 / 1900	730	38°	3000K	220-240V	DIMM.	0,172	48,15

DISEGNI TECNICI TECHNICAL DRAWING

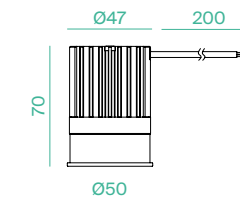

MODULO LED + ADATTATORE FOR LIGHT_50



LED BRIDGELUX
CRI >90
PF >0,9

CODE	WATT	LUMEN	BEAM	KELVIN	DRIVER	MODE	KG	PRICE
71606	9W	715	15°	3000K	30-42V 200mA	ON-OFF	0,16	29,87
71607	9W	725	24°	3000K	30-42V 200mA	ON-OFF	0,16	29,87
71608	9W	710	38°	3000K	30-42V 200mA	ON-OFF	0,16	29,87
71609	9W	695	55°	3000K	30-42V 200mA	ON-OFF	0,16	29,87
71610	12W	1015	15°	3000K	30-42V 300mA	ON-OFF	0,23	30,90
71611	12W	1055	24°	3000K	30-42V 300mA	ON-OFF	0,23	30,90
71612	12W	1050	38°	3000K	30-42V 300mA	ON-OFF	0,23	30,90
71613	12W	1000	55°	3000K	30-42V 300mA	ON-OFF	0,23	30,90
71614	15W	1150	15°	3000K	30-42V 350mA	ON-OFF	0,23	31,93
71615	15W	1170	24°	3000K	30-42V 350mA	ON-OFF	0,23	31,93
71616	15W	1155	38°	3000K	30-42V 350mA	ON-OFF	0,23	31,93
71617	15W	1110	55°	3000K	30-42V 350mA	ON-OFF	0,23	31,93
71618	9W	715	15°	3000K	30-42V 200mA	1-10V	0,16	46,61
71619	9W	725	24°	3000K	30-42V 200mA	1-10V	0,16	46,61
71620	9W	710	38°	3000K	30-42V 200mA	1-10V	0,16	46,61
71621	9W	695	55°	3000K	30-42V 200mA	1-10V	0,16	46,61
71622	12W	1015	15°	3000K	30-42V 300mA	1-10V	0,23	52,53
71623	12W	1055	24°	3000K	30-42V 300mA	1-10V	0,23	52,53
71624	12W	1050	38°	3000K	30-42V 300mA	1-10V	0,23	52,53
71625	12W	1000	55°	3000K	30-42V 300mA	1-10V	0,23	52,53
71626	15W	1150	15°	3000K	30-42V 350mA	1-10V	0,23	57,17
71627	15W	1170	24°	3000K	30-42V 350mA	1-10V	0,23	57,17
71628	15W	1155	38°	3000K	30-42V 350mA	1-10V	0,23	57,17
71629	15W	1110	55°	3000K	30-42V 350mA	1-10V	0,23	57,17
71763	9W	715	15°	3000K	30-42V 200mA	DALI/PUSH	0,16	71,07
71764	9W	725	24°	3000K	30-42V 200mA	DALI/PUSH	0,16	71,07
71765	9W	710	38°	3000K	30-42V 200mA	DALI/PUSH	0,16	71,07
71766	9W	695	55°	3000K	30-42V 200mA	DALI/PUSH	0,16	71,07
71767	12W	1015	15°	3000K	30-42V 300mA	DALI/PUSH	0,23	71,33
71768	12W	1055	24°	3000K	30-42V 300mA	DALI/PUSH	0,23	71,33
71769	12W	1050	38°	3000K	30-42V 300mA	DALI/PUSH	0,23	71,33
71774	15W	1110	55°	3000K	30-42V 350mA	DALI/PUSH	0,23	75,19
71770	12W	1000	55°	3000K	30-42V 300mA	DALI/PUSH	0,23	71,33
71771	15W	1150	15°	3000K	30-42V 350mA	DALI/PUSH	0,23	75,19
71772	15W	1170	24°	3000K	30-42V 350mA	DALI/PUSH	0,23	75,19
71773	15W	1155	38°	3000K	30-42V 350mA	DALI/PUSH	0,23	75,19

ACCESSORI ACCESSORIES



CODE	DESCRIPTION	PRICE
71575	Filtro honeycomb 9W-12W-15W/ Honeycomb filter 9W-12W-15W	4,85

LIGHT_111



CODE	FINISHING	BASE	WATT	VOLT	KG	PRICE
41285	Bianco/White	GU10	Max 50W	230V 50/60Hz	0,200	20,19
41286	Nero/Black	GU10	Max 50W	230V 50/60Hz	0,200	20,19
41289	Oro/Gold	GU10	Max 50W	230V 50/60Hz	0,200	30,39

INSTALLAZIONE APPLICATION

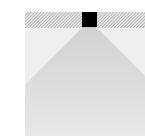

Incasso/Recessed

DISEGNI TECNICI TECHNICAL DRAWING

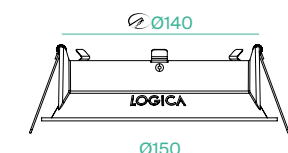

LUMIS_T



LED BRIDGELUX V8
CRI >90
PF 0,5
SDCM ≥3

CODE	FINISHING	WATT	LUMEN	WATT LIGHT SOURCE	LUMEN LIGHT SOURCE	BEAM	KELVIN	DRIVER	MODE	KG	PRICE
71948	Bianco/White	12W	1230	10,9W	1460	38°	3000K	30-42V/300mA	ON-OFF	0,19	28,50
71949	Nero/Black	12W	1230	10,9W	1460	38°	3000K	30-42V/300mA	ON-OFF	0,19	28,50
71950	Bianco/White	12W	1230	10,9W	1460	38°	3000K	30-42V/300mA	1-10V	0,19	49,24
71951	Nero/Black	12W	1230	10,9W	1460	38°	3000K	30-42V/300mA	1-10V	0,19	49,24
71952	Bianco/White	12W	1230	10,9W	1460	38°	3000K	30-42V/300mA	DALI	0,19	67,96
71953	Nero/Black	12W	1230	10,9W	1460	38°	3000K	30-42V/300mA	DALI	0,19	67,96

INSTALLAZIONE APPLICATION

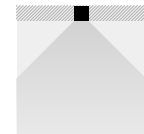

Incasso/Recessed

DISEGNI TECNICI TECHNICAL DRAWING

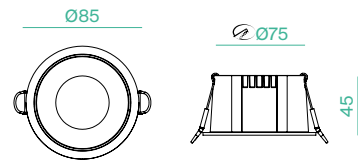

LUMIS_Q



LED BRIDGELUX V8
CRI >90
PF 0,5
SDCM ≥3

CODE	FINISHING	WATT	LUMEN	WATT LIGHT SOURCE	LUMEN LIGHT SOURCE	BEAM	KELVIN	DRIVER	MODE	KG	PRICE
71956	Bianco/White	12W	1230	10,9W	1460	38°	3000K	30-42V/300mA	ON-OFF	0,22	29,96
71957	Nero/Black	12W	1230	10,9W	1460	38°	3000K	30-42V/300mA	ON-OFF	0,22	29,96
71958	Bianco/White	12W	1230	10,9W	1460	38°	3000K	30-42V/300mA	1-10V	0,22	50,08
71959	Nero/Black	12W	1230	10,9W	1460	38°	3000K	30-42V/300mA	1-10V	0,22	50,08
71960	Bianco/White	12W	1230	10,9W	1460	38°	3000K	30-42V/300mA	DALI	0,22	68,44
71961	Nero/Black	12W	1230	10,9W	1460	38°	3000K	30-42V/300mA	DALI	0,22	68,44

INSTALLAZIONE APPLICATION

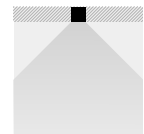

Incasso/Recessed

DISEGNI TECNICI TECHNICAL DRAWING

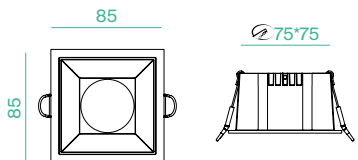

FULGOR_IN INCASSO



LED BRIDGELUX
CRI >90
PF >0,95

CODE	FINISHING	WATT	LUMEN	WATT LIGHT SOURCE	LUMEN LIGHT SOURCE	BEAM	KELVIN	DRIVER	KG	PRICE
41686	Bianco/White	24W	2220	24W	2640	15°	3000K	30-42V 600mA	0,78	89,51
41688	Nero/Black	24W	2220	24W	2640	15°	3000K	30-42V 600mA	0,78	89,51
41687	Bianco/White	24W	2400	24W	2880	15°	4000K	30-42V 600mA	0,78	89,51
41689	Nero/Black	24W	2400	24W	2880	15°	4000K	30-42V 600mA	0,78	89,51
41690	Bianco/White	24W	2280	24W	2640	24°	3000K	30-42V 600mA	0,78	89,51
41692	Nero/Black	24W	2280	24W	2640	24°	3000K	30-42V 600mA	0,78	89,51
41691	Bianco/White	24W	2480	24W	2880	24°	4000K	30-42V 600mA	0,78	89,51
41693	Nero/Black	24W	2480	24W	2880	24°	4000K	30-42V 600mA	0,78	89,51
41682	Bianco/White	24W	2340	24W	2640	38°	3000K	30-42V 600mA	0,78	89,51
41684	Nero/Black	24W	2340	24W	2640	38°	3000K	30-42V 600mA	0,78	89,51
41683	Bianco/White	24W	2550	24W	2880	38°	4000K	30-42V 600mA	0,78	89,51
41685	Nero/Black	24W	2550	24W	2880	38°	4000K	30-42V 600mA	0,78	89,51
41694	Bianco/White	24W	2310	24W	2640	55°	3000K	30-42V 600mA	0,78	89,51
41696	Nero/Black	24W	2310	24W	2640	55°	3000K	30-42V 600mA	0,78	89,51
41695	Bianco/White	24W	2510	24W	2880	55°	4000K	30-42V 600mA	0,78	89,51
41697	Nero/Black	24W	2510	24W	2880	55°	4000K	30-42V 600mA	0,78	89,51

INSTALLAZIONE APPLICATION



Incasso/Recessed

DISEGNI TECNICI TECHNICAL DRAWINGS

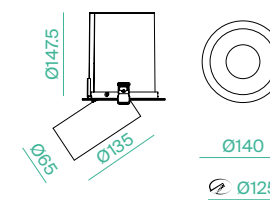

REGOLAZIONI ADJUSTABILITY



ACCESSORI ACCESSORIES

CODE	DESCRIPTION	PRICE
71663	Filtro Honeycomb 24W Honeycomb Filter 24W	5,46

BELLATRIX



LED OSRAM
CRI >90
PF >0,9
UGR <19

CODE	FINISHING	WATT	LUMEN	BEAM	KELVIN	KG	PRICE
51011	Bianco/White	10,8W	1234/1278	55°	3000K/4000K	0,15	27,25
51012	Bianco/White	16,2W	1712/1779	55°	3000K/4000K	0,19	29,85
51013	Bianco/White	21,6W	2430/2500	55°	3000K/4000K	0,26	47,24
51014	Bianco/White	27W	2961/3140	55°	3000K/4000K	0,35	57,62
51015	Bianco/White	32,4W	3357/3569	55°	3000K/4000K	0,35	60,21

INSTALLAZIONE
APPLICATION

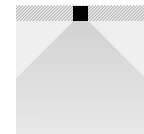

Incasso/Recessed

DISEGNI TECNICI
TECHNICAL DRAWINGS

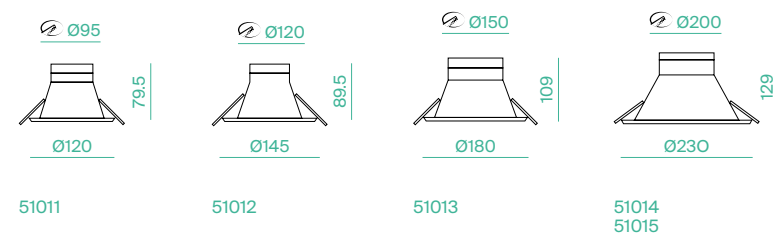

DRIVER

CODE	DESCRIPTION	VOLT	CURRENT	MODE	PRICE
51016	Driver 12W (10,8W)	36V DC	300mA	ON-OFF	13,49
51017	Driver 18W (16,2W)	36V DC	450mA	ON-OFF	15,06
51018	Driver 23W (21,6W)	36V DC	600mA	ON-OFF	16,61
51019	Driver 28W (27W)	36V DC	750mA	ON-OFF	16,61
51020	Driver 35W (32,4W)	36V DC	900mA	ON-OFF	16,61
51021	Driver Dimming 12W (10,8W)	36V DC	300mA	TRIAC	21,28
51022	Driver Dimming 18W (16,2W)	36V DC	450mA	TRIAC	22,85
51023	Driver Dimming 23W (21,6W)	36V DC	600mA	TRIAC	33,23
51024	Driver Dimming 28W (27W)	36V DC	750mA	TRIAC	33,23
51025	Driver Dimming 35W (32,4W)	36V DC	900mA	TRIAC	39,97
51026	Driver 12W (10,8W)	36V DC	300mA	DALI	43,31
51027	Driver 18W/23W (16,2W / 21,6W)	36V DC	450-600mA	DALI	54,02
51028	Driver 28W/35W (27W / 32,4W)	36V DC	750-900mA	DALI	59,86

PUNTO



LED BRIDGELUX
CRI >90

CODE	BODY FINISHING	FINISHING REFLECTOR	WATT	LUMEN	WATT LIGHT SOURCE	LUMEN LIGHT SOURCE	BEAM	KELVIN	KG	PRICE
42686	Bianco/White	Bianco/White	1,6W	100	1,6W	130	30°	3000K	0,07	37,99
42687	Bianco/White	Argento/Silver	1,6W	100	1,6W	130	30°	3000K	0,07	37,99
42688	Bianco/White	Oro/Gold	1,6W	100	1,6W	130	30°	3000K	0,07	37,99
42689	Bianco/White	Nero/Black	1,6W	100	1,6W	130	30°	3000K	0,07	37,99
42693	Nero/Black	Bianco/White	1,6W	100	1,6W	130	30°	3000K	0,07	37,99
42691	Nero/Black	Argento/Silver	1,6W	100	1,6W	130	30°	3000K	0,07	37,99
42692	Nero/Black	Oro/Gold	1,6W	100	1,6W	130	30°	3000K	0,07	37,99
42690	Nero/Black	Nero/Black	1,6W	100	1,6W	130	30°	3000K	0,07	37,99

INSTALLAZIONE
APPLICATION

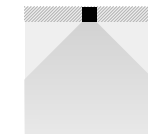

Incasso/Recessed

DISEGNI TECNICI
TECHNICAL DRAWINGS

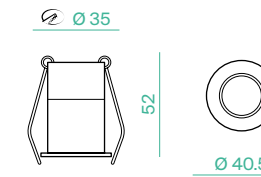

DRIVER

CODE	VOLT	CURRENT	PF	SIZE	MODE	PRICE
42703	2,52-8V	500mA	>0.5	72x22x22	ON-OFF	7,17

PUNTO L



LED
CRI >90

CODE	BODY FINISHING	FINISHING REFLECTOR	WATT	LUMEN	WATT LIGHT SOURCE	LUMEN LIGHT SOURCE	BEAM	KELVIN	KG	PRICE
42694	Bianco/White	Bianco/White	6W	450	6W	600	25°	3000K	0,12	47,87
42695	Bianco/White	Argento/Silver	6W	450	6W	600	25°	3000K	0,12	47,87
42696	Bianco/White	Oro/Gold	6W	450	6W	600	25°	3000K	0,12	47,87
42697	Bianco/White	Nero/Black	6W	450	6W	600	25°	3000K	0,12	47,87
42701	Nero/Black	Bianco/White	6W	450	6W	600	25°	3000K	0,12	47,87
42699	Nero/Black	Argento/Silver	6W	450	6W	600	25°	3000K	0,12	47,87
42700	Nero/Black	Oro/Gold	6W	450	6W	600	25°	3000K	0,12	47,87
42698	Nero/Black	Nero/Black	6W	450	6W	600	25°	3000K	0,12	47,87

INSTALLAZIONE APPLICATION

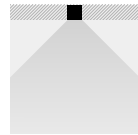

Incasso/Recessed

DISEGNI TECNICI TECHNICAL DRAWINGS

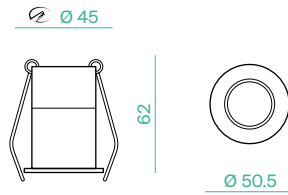

DRIVER

CODE	VOLT	CURRENT	PF	SIZE	MODE	PRICE
42704	9-20V	500mA	0.5	135x30x20	TRIAC Dimming	16,88
42705	12-24V	500mA	0.82	86x32x23	ON-OFF	11,67

OCCHIO

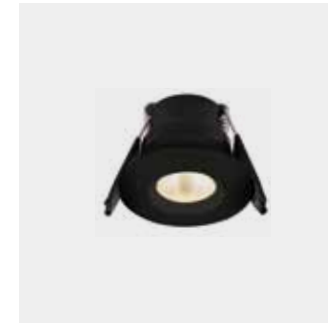

LED
CRI >90

41063 - 41064

41065 - 41066

CODE	FINISHING	WATT	LUMEN	WATT LIGHT SOURCE	LUMEN LIGHT SOURCE	BEAM	KELVIN	KG	PRICE
41063	Bianco/White	3,5W	250	3,5W	380	60°	3000K	0,06	28,98
41064	Nero/Black	3,5W	250	3,5W	380	60°	3000K	0,06	28,98
41065	Bianco/White	3,5W	250	3,5W	380	60°	3000K	0,06	31,17
41066	Nero/Black	3,5W	250	3,5W	380	60°	3000K	0,06	31,17

INSTALLAZIONE APPLICATION



Incasso/Recessed

DISEGNI TECNICI TECHNICAL DRAWINGS



41063
41064

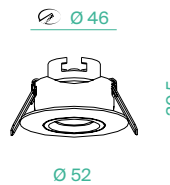

41065
41066

REGOLAZIONI ADJUSTABILITY



DRIVER

CODE	VOLT	CURRENT	PF	SIZE	MODE	PRICE
12557	7-14V	300mA	>0.5	53x27x21	ON-OFF	12,03
12556	6-12V	300mA	>0.5	40x32x20	PHASE-CUT DIMMING	18,11

MINI 20



LED
CRI >80

CODE	FINISHING	WATT	LUMEN	WATT LIGHT SOURCE	LUMEN LIGHT SOURCE	BEAM	KELVIN	KG	PRICE
42737	Bianco/White	1,2W	92	1,2W	120	20°	3000K	0,04	18,84
42738	Nero/Black	1,2W	92	1,2W	120	20°	3000K	0,04	18,84

INSTALLAZIONE
APPLICATION

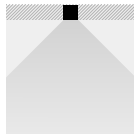

Incasso/Recessed

DISEGNI TECNICI
TECHNICAL DRAWINGS

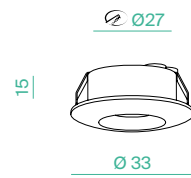

5 YEAR WARRANTY LED III IP44 CE

DRIVER

CODE	VOLT	CURRENT	PF	SIZE	MODE	PRICE
42743	2-5V	350mA	0.5	53x31x21	ON-OFF	11,30

MINI 105

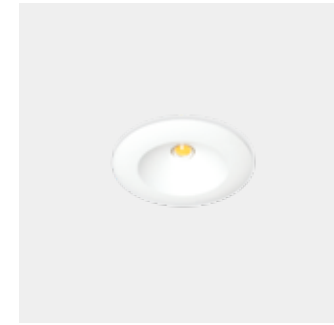

LED
CRI >80

CODE	FINISHING	WATT	LUMEN	WATT LIGHT SOURCE	LUMEN LIGHT SOURCE	BEAM	KELVIN	KG	PRICE
42739	Bianco/White	1,2W	71	1,2W	120	105°	3000K	0,03	18,84
42740	Nero/Black	1,2W	71	1,2W	120	105°	3000K	0,03	18,84

INSTALLAZIONE
APPLICATION

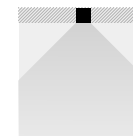

Incasso/Recessed

DISEGNI TECNICI
TECHNICAL DRAWINGS

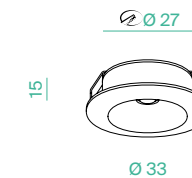

5 YEAR WARRANTY LED III IP20 CE

DRIVER

CODE	VOLT	CURRENT	PF	SIZE	MODE	PRICE
42743	2-5V	350mA	0.5	53x31x21	ON-OFF	11,30

MINI 60

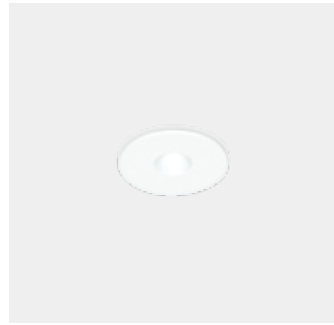

LED
CRI OSRAM
>80

CODE	FINISHING	WATT	LUMEN	WATT LIGHT SOURCE	LUMEN LIGHT SOURCE	BEAM	KELVIN	KG	PRICE
42741	Bianco/White	1,2W	94	1,2W	120	60°	3000K	0,03	18,84
42742	Nero/Black	1,2W	94	1,2W	120	60°	3000K	0,03	18,84

INSTALLAZIONE
APPLICATION

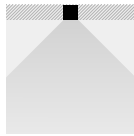

Incasso/Recessed

DISEGNI TECNICI
TECHNICAL DRAWINGS

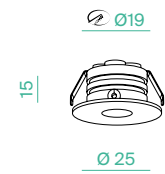

DRIVER

CODE	VOLT	CURRENT	PF	SIZE	MODE	PRICE
42743	2-5V	350mA	0.5	53x31x21	ON-OFF	11,30

ZEUS



LED
CRI EPISTAR
>80

CODE	FINISHING	WATT	LUMEN	WATT LIGHT SOURCE	LUMEN LIGHT SOURCE	BEAM	KELVIN	KG	PRICE
42745	Bianco/White	3W	285	3W	360	90°	3000K	0,07	21,26
42744	Nero/Black	3W	285	3W	360	90°	3000K	0,07	21,26

INSTALLAZIONE
APPLICATION

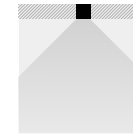

Incasso/Recessed

DISEGNI TECNICI
TECHNICAL DRAWINGS



DRIVER

CODE	VOLT	CURRENT	PF	SIZE	MODE	PRICE
12557	7-14V	300mA	>0.5	53x27x21	ON-OFF	12,03
12556	6-12V	300mA	>0.5	40x32x20	PHASE-CUT DIMMING	18,11

AQUA_EVO COB



LED HONGLI
CRI >80
PF >0,7
SDCM <6

CODE	FINISHING	WATT	LUMEN	LUMEN LIGHT SOURCE	BEAM	KELVIN	KG	PRICE
40624	Bianco/White	8W	800	750 (90°)	60°	2700/3000/4000K	0,198	36,57

INSTALLAZIONE APPLICATION

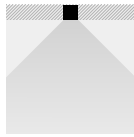

Incasso/Recessed

DISEGNI TECNICI TECHNICAL DRAWINGS

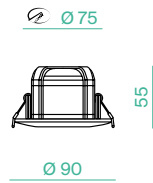

AQUA_EVO SMD

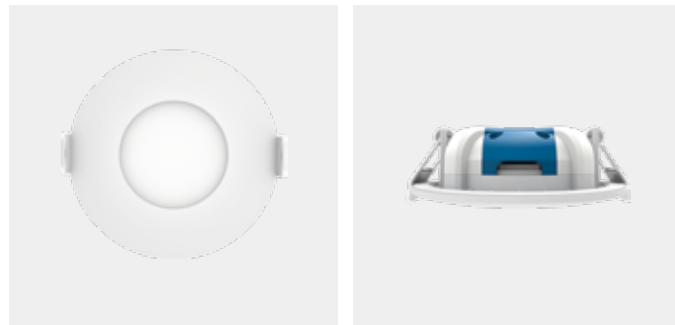

LED HONGLI
CRI >80
PF >0,7
SDCM <6

CODE	FINISHING	WATT	LUMEN	LUMEN LIGHT SOURCE	BEAM	KELVIN	KG	PRICE
40619	Bianco/White	6W	540	420 (120°)	110°	2700/3000/4000K	0,122	21,69

INSTALLAZIONE APPLICATION

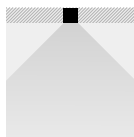

Incasso/Recessed

DISEGNI TECNICI TECHNICAL DRAWINGS

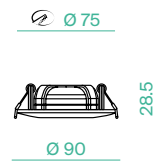

FRAME



Lampadina esclusa / Bulb not included

CODE	FINISHING	BASE	WATT	VOLT	SIZE	KG	PRICE
53421/GU10	Bianco/White	GU10	Max 50W	230V 50/60Hz	118x118x110	0,60	41,30
53426/GU10	Nero/Black	GU10	Max 50W	230V 50/60Hz	118x118x110	0,60	41,30

INSTALLAZIONE APPLICATION

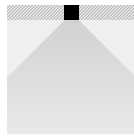

Incasso/Recessed

DISEGNI TECNICI TECHNICAL DRAWINGS

106x106

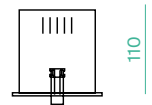

118x118

REGOLAZIONI ADJUSTABILITY



±45°



FRAME



Lampadina esclusa / Bulb not included

CODE	FINISHING	BASE	WATT	VOLT	SIZE	KG	PRICE
53425/GU10	Bianco/White	GU10	Max 3x50W	230V 50/60Hz	315x118x110	1,00	94,12
53428/GU10	Nero/Black	GU10	Max 3x50W	230V 50/60Hz	315x118x110	1,00	94,12

INSTALLAZIONE APPLICATION

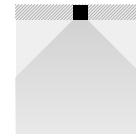

Incasso/Recessed

DISEGNI TECNICI TECHNICAL DRAWINGS

303x106

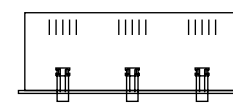

315x118

REGOLAZIONI ADJUSTABILITY



±45°



FRAME



Lampadina esclusa / Bulb not included

CODE	FINISHING	BASE	WATT	VOLT	SIZE	KG	PRICE
53423/GU10	Bianco/White	GU10	Max 2x50W	230V 50/60Hz	223x118x110	0,80	67,71
53427/GU10	Nero/Black	GU10	Max 2x50W	230V 50/60Hz	223x118x110	0,80	67,71

INSTALLAZIONE APPLICATION

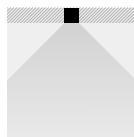

Incasso/Recessed

DISEGNI TECNICI TECHNICAL DRAWINGS

211x106

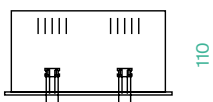

223x118

REGOLAZIONI ADJUSTABILITY



±45°



FRAME 111

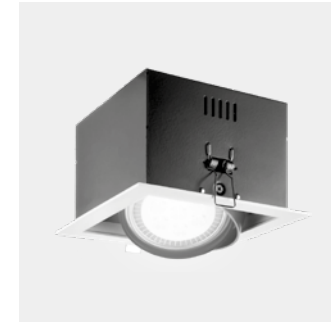

Lampadina esclusa / Bulb not included

CODE	FINISHING	BASE	WATT	VOLT	SIZE	KG	PRICE
53433/GU10	Bianco/White	AR111 GU10	Max 50W	230V 50/60Hz	191x191x150	1,00	55,67
53429/GU10	Nero/Black	AR111 GU10	Max 50W	230V 50/60Hz	191x191x150	1,00	55,67

INSTALLAZIONE APPLICATION

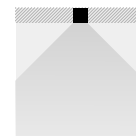

Incasso/Recessed

DISEGNI TECNICI TECHNICAL DRAWINGS

172x172

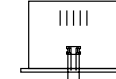

191x191

REGOLAZIONI ADJUSTABILITY



±45°



FRAME 111



Lampadina esclusa / Bulb not included

CODE	FINISHING	BASE	WATT	VOLT	SIZE	KG	PRICE
53435/GU10	Bianco/White	AR111 GU10	Max 2x50W	230V 50/60Hz	357x191x150	1,80	92,04
53430/GU10	Nero/Black	AR111 GU10	Max 2x50W	230V 50/60Hz	357x191x150	1,80	92,04

INSTALLAZIONE APPLICATION

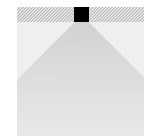

Incasso/Recessed

DISEGNI TECNICI TECHNICAL DRAWINGS

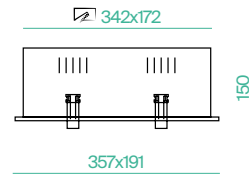

REGOLAZIONI ADJUSTABILITY



FRAMELESS



Lampadina esclusa / Bulb not included

CODE	FINISHING	BASE	WATT	VOLT	SIZE	KG	PRICE
53448B/GU10	Bianco/White	GU10	Max 50W	230V 50/60Hz	97x97x120	0,80	48,97
53448/GU10	Nero/Black	GU10	Max 50W	230V 50/60Hz	97x97x120	0,80	48,97

INSTALLAZIONE APPLICATION

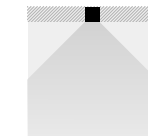

Incasso/Recessed

DISEGNI TECNICI TECHNICAL DRAWINGS

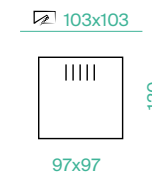

REGOLAZIONI ADJUSTABILITY



FRAME 111



Lampadina esclusa / Bulb not included

CODE	FINISHING	BASE	WATT	VOLT	SIZE	KG	PRICE
53437/GU10	Bianco/White	AR111 GU10	Max 3x50W	230V 50/60Hz	509x191x150	2,40	131,29
53431/GU10	Nero/Black	AR111 GU10	Max 3x50W	230V 50/60Hz	509x191x150	2,40	131,29

INSTALLAZIONE APPLICATION

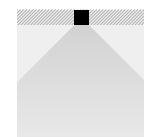

Incasso/Recessed

DISEGNI TECNICI TECHNICAL DRAWINGS

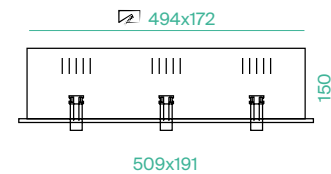

REGOLAZIONI ADJUSTABILITY



FRAMELESS



Lampadina esclusa / Bulb not included

CODE	FINISHING	BASE	WATT	VOLT	SIZE	KG	PRICE
53449B/GU10	Bianco/White	GU10	Max 2x50W	230V 50/60Hz	202x97x120	1,00	74,76
53449/GU10	Nero/Black	GU10	Max 2x50W	230V 50/60Hz	223x118x110	1,00	74,76

INSTALLAZIONE APPLICATION

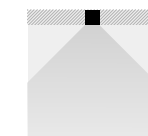

Incasso/Recessed

DISEGNI TECNICI TECHNICAL DRAWINGS

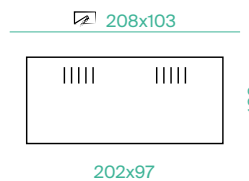

REGOLAZIONI ADJUSTABILITY



FRAMELESS



Lampadina esclusa / Bulb not included

CODE	FINISHING	BASE	WATT	VOLT	SIZE	KG	PRICE
53450B/GU10	Bianco/White	GU10	Max 3x50W	230V 50/60Hz	294x97x120	1,40	101,93
53450/GU10	Nero/Black	GU10	Max 3x50W	230V 50/60Hz	294x97x120	1,40	101,93

INSTALLAZIONE APPLICATION

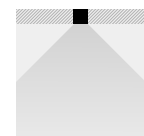

Incasso/Recessed

DISEGNI TECNICI TECHNICAL DRAWINGS



REGOLAZIONI ADJUSTABILITY



FRAMELESS 111



Lampadina esclusa / Bulb not included

CODE	FINISHING	BASE	WATT	VOLT	SIZE	KG	PRICE
53455B/GU10	Bianco/White	AR111 GU10	Max 2x50W	230V 50/60Hz	325x157x150	1,80	102,78
53455/GU10	Nero/Black	AR111 GU10	Max 2x50W	230V 50/60Hz	325x157x150	1,80	102,78

INSTALLAZIONE APPLICATION



Incasso/Recessed

DISEGNI TECNICI TECHNICAL DRAWINGS



REGOLAZIONI ADJUSTABILITY



FRAMELESS 111



Lampadina esclusa / Bulb not included

CODE	FINISHING	BASE	WATT	VOLT	SIZE	KG	PRICE
53454B/GU10	Bianco/White	AR111 GU10	Max 50W	230V 50/60Hz	157x157x150	1,00	64,24
53454/GU10	Nero/Black	AR111 GU10	Max 50W	230V 50/60Hz	157x157x150	1,00	64,24

INSTALLAZIONE APPLICATION

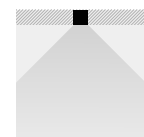

Incasso/Recessed

DISEGNI TECNICI TECHNICAL DRAWINGS

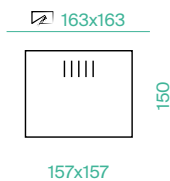

REGOLAZIONI ADJUSTABILITY



FRAMELESS 111



Lampadina esclusa / Bulb not included

CODE	FINISHING	BASE	WATT	VOLT	SIZE	KG	PRICE
53456B/GU10	Bianco/White	AR111 GU10	Max 3x50W	230V 50/60Hz	477x157x150	2,40	136,67
53456/GU10	Nero/Black	AR111 GU10	Max 3x50W	230V 50/60Hz	477x157x150	2,40	136,67

INSTALLAZIONE APPLICATION

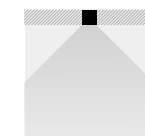

Incasso/Recessed

DISEGNI TECNICI TECHNICAL DRAWINGS



REGOLAZIONI ADJUSTABILITY

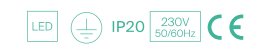

WIZARD



Lampadina esclusa / Bulb not included

CODE	FINISHING	BASE	WATT	VOLT	KG	PRICE
42749	Bianco/White	GU10	Max 50W	230V 50/60Hz	0,20	24,18
42750	Nero/Black	GU10	Max 50W	230V 50/60Hz	0,20	24,18
42747	Bianco/White	AR111 GU10	Max 50W	230V 50/60Hz	0,43	33,90
42748	Nero/Black	AR111 GU10	Max 50W	230V 50/60Hz	0,43	33,90

INSTALLAZIONE APPLICATION

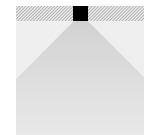

Incasso/Recessed

DISEGNI TECNICI TECHNICAL DRAWINGS

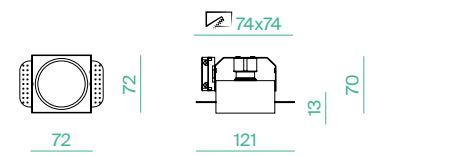

42749
42750

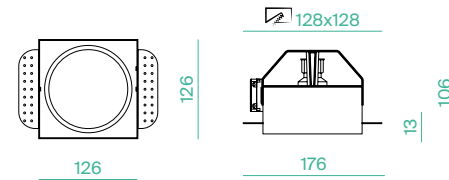

42747
42748

REGOLAZIONI ADJUSTABILITY



A+B SOSPENSIONE DALI-PUSH



LED EPISTAR
CRI >90
PF >0.9
SDCM <6
UGR <16

CODE	FINISHING	WATT	LUMEN	WATT LIGHT SOURCE	LUMEN LIGHT SOURCE	BEAM	KELVIN	DRIVER	MODE	KG	PRICE
41885	Bianco/White	↓ 26W+ ↑ 12W	2412+1471	26W+11,6W	3236+1501	90°+120°	3000K	38W 30-40V 1050mA	ON-OFF, DALI, PUSH	4,00	419,99
41887	Bianco/White	↓ 26W+ ↑ 12W	2629+1603	26W+11,6W	3603+1636	90°+120°	4000K	38W 30-40V 1050mA	ON-OFF, DALI, PUSH	4,00	419,99
41886	Bianco/White	↓ 38W+ ↑ 20W	3570+2317	36W+20W	4109+2685	90°+120°	3000K	38W 30-40V 1050mA + 20W 30-40V 500mA	ON-OFF, DALI, PUSH	5,20	567,68
41888	Bianco/White	↓ 38W+ ↑ 20W	3892+2525	36W+20W	4782+2926	90°+120°	4000K	38W 30-40V 1050mA + 20W 30-40V 500mA	ON-OFF, DALI, PUSH	5,20	567,68

INSTALLAZIONE APPLICATION

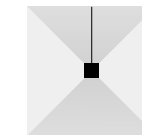

Sospensione/
Suspension

DISEGNI TECNICI TECHNICAL DRAWINGS

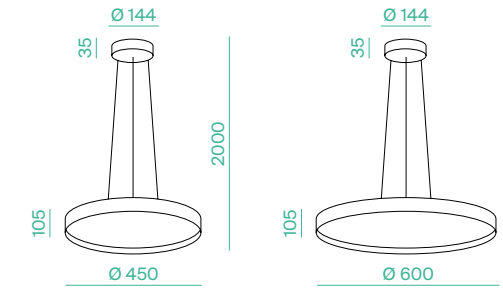

41885
41887

41886
41888

SHANGHAI_30



LED CREE
CRI >90
PF >0.5

CODE	FINISHING	WATT	LUMEN	WATT LIGHT SOURCE	LUMEN LIGHT SOURCE	BEAM	KELVIN	KG	PRICE
43160	Nero/Black	6W	256	4,8W	450	15°	3000K	0,55	96,00
43161	Bianco/White	6W	256	4,8W	450	15°	3000K	0,55	96,00

INSTALLAZIONE
APPLICATION

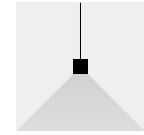

Sospensione/
Suspension

DISEGNI TECNICI
TECHNICAL DRAWINGS

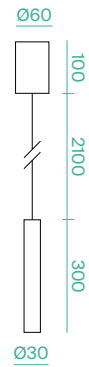

SHANGHAI_50



LED EPISTAR
CRI >90
PF >0.9
SDCM <6
UGR <16

CODE	FINISHING	WATT	LUMEN	WATT LIGHT SOURCE	LUMEN LIGHT SOURCE	BEAM	KELVIN	KG	PRICE
43162	Nero/Black	6W	256	4,8W	450	15°	3000K	0,55	108,15
43163	Bianco/White	6W	256	4,8W	450	15°	3000K	0,55	108,15

INSTALLAZIONE
APPLICATION

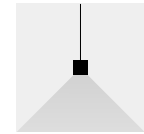

Sospensione/
Suspension

DISEGNI TECNICI
TECHNICAL DRAWINGS

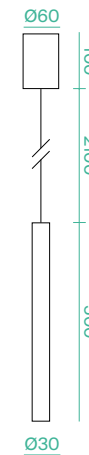

CYL SOSP



LED BRIDGELUX
CRI >90
PF >0.5

CODE	FINISHING	WATT	LUMEN	WATT LIGHT SOURCE	LUMEN LIGHT SOURCE	BEAM	KELVIN	KG	PRICE
41707	Nero/Black	12W	890	12W	1680	55°	3000K	0,86	113,50
41708	Bianco/White	12W	890	12W	1680	55°	3000K	0,86	113,50

INSTALLAZIONE
APPLICATION

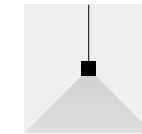

Sospensione/
Suspension

DISEGNI TECNICI
TECHNICAL DRAWINGS

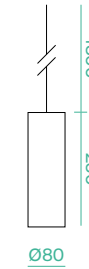

A+B SOFFITTO DALI-PUSH

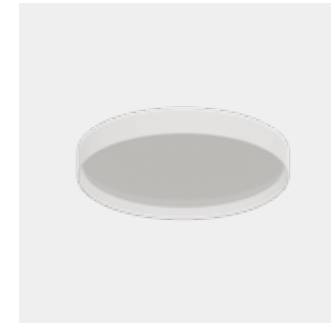

LED EPISTAR
CRI >90
PF >0.9
SDCM <6
UGR <16

CODE	FINISHING	WATT	LUMEN	WATT LIGHT SOURCE	LUMEN LIGHT SOURCE	BEAM	KELVIN	DRIVER	KG	PRICE
41889	Bianco/White	↓ 26W+ ↑ 12W	2412+1471	26W+11,6W	3236+1501	90°+120°	3000K	38W 30-40V 1050mA	3,60	375,90
41891	Bianco/White	↓ 26W+ ↑ 12W	2412+1471	26W+11,6W	3236+1501	90°+120°	4000K	38W 30-40V 1050mA	3,60	375,90
41890	Bianco/White	↓ 38W+ ↑ 20W	3570+2317	36W+20W	4109+2685	90°+120°	3000K	38W 30-40V 1050mA + 20W 30-40V 500mA	4,80	529,70
41892	Bianco/White	↓ 38W+ ↑ 20W	3570+2317	36W+20W	4109+2685	90°+120°	4000K	38W 30-40V 1050mA + 20W 30-40V 500mA	4,80	529,70

INSTALLAZIONE
APPLICATION



Soffitto/Ceiling

DISEGNI TECNICI
TECHNICAL DRAWINGS



41889
41891

41890
41892



FULGOR SOFFITTO/ PARETE



LED
CRI >90
PF >0,9

CODE	FINISHING	WATT	LUMEN	WATT LIGHT SOURCE	LUMEN LIGHT SOURCE	BEAM	KELVIN	VOLT	KG	PRICE
41869	Bianco/ White	15W	1560	14,8W	1710	15°	3000K	36-38V 350mA	0,60	66,56
41877	Nero/Black	15W	1560	14,8W	1710	15°	3000K	36-38V 350mA	0,60	66,56
41873	Bianco/ White	15W	1557	14,8W	1834	15°	4000K	36-38V 350mA	0,60	66,56
41881	Nero/Black	15W	1557	14,8W	1834	15°	4000K	36-38V 350mA	0,60	66,56
41870	Bianco/ White	15W	1574	14,8W	1710	24°	3000K	36-38V 350mA	0,60	66,56
41878	Nero/Black	15W	1574	14,8W	1710	24°	3000K	36-38V 350mA	0,60	66,56
41874	Bianco/ White	15W	1584	14,8W	1834	24°	4000K	36-38V 350mA	0,60	66,56
41882	Nero/Black	15W	1584	14,8W	1834	24°	4000K	36-38V 350mA	0,60	66,56
41871	Bianco/ White	15W	1591	14,8W	1710	38°	3000K	36-38V 350mA	0,60	66,56
41879	Nero/Black	15W	1591	14,8W	1710	38°	3000K	36-38V 350mA	0,60	66,56
41875	Bianco/ White	15W	1585	14,8W	1834	38°	4000K	36-38V 350mA	0,60	66,56
41883	Nero/Black	15W	1585	14,8W	1834	38°	4000K	36-38V 350mA	0,60	66,56
41872	Bianco/ White	15W	1509	14,8W	1710	55°	3000K	36-38V 350mA	0,60	66,56
41880	Nero/Black	15W	1509	14,8W	1710	55°	3000K	36-38V 350mA	0,60	66,56
41876	Bianco/ White	15W	1531	14,8W	1834	55°	4000K	36-38V 350mA	0,60	66,56
41884	Nero/Black	15W	1531	14,8W	1834	55°	4000K	36-38V 350mA	0,60	66,56

INSTALLAZIONE APPLICATION



Soffitto/Ceiling



Parete/Wall

DISEGNI TECNICI TECHNICAL DRAWINGS

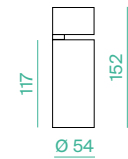

REGOLAZIONI ADJUSTABILITY



SUN_111 SOFFITTO/PARETE



Lampadina esclusa / Bulb not included

CODE	FINISHING	BASE	WATT	VOLT	KG	PRICE
41915	Bianco/White	AR111 GU10	Max 50W	230V 50/60Hz	0,44	38,01
41916	Nero/Black	AR111 GU10	Max 50W	230V 50/60Hz	0,44	38,01

INSTALLAZIONE APPLICATION



Soffitto/Ceiling



Parete/Wall

DISEGNI TECNICI TECHNICAL DRAWINGS

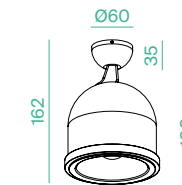

REGOLAZIONI ADJUSTABILITY



ACCESSORI ACCESSORIES

CODE	DESCRIPTION	PRICE
71575	Filtro Honeycomb 15W Honeycomb Filter 15W	4,85



UNICO DICRO SOFFITTO/PARETE

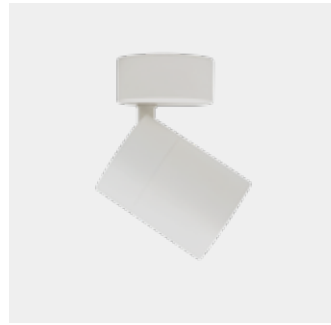

Lampadina esclusa /
Bulb not included

CODE	FINISHING	BASE	WATT	VOLT	KG	PRICE
40760	Bianco/White	GU10	Max 50W	230V 50/60HZ	0,26	61,98
40761	Nero/Black	GU10	Max 50W	230V 50/60HZ	0,26	61,98

INSTALLAZIONE APPLICATION

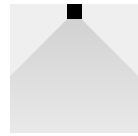

Soffitto/Ceiling



Parete/Wall

DISEGNI TECNICI TECHNICAL DRAWINGS

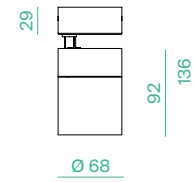

REGOLAZIONI ADJUSTABILITY



KLIK KLAK PUNTIFORME SOFFITTO



LED LIGHTNING
CRI 90
PF 0.6
SDCM 3

CODE	FINISHING	WATT	LUMEN	WATT LIGHT SOURCE	LUMEN LIGHT SOURCE	BEAM	KELVIN	KG	PRICE
41917	Nero/Black	12W	1000	10W	1298	30°	3000K	0,40	66,95
41918	Bianco/White	12W	1000	10W	1298	30°	3000K	0,40	66,95
41919	Nero/Black	22W	2065	20W	2622	30°	3000K	0,60	93,73
41920	Bianco/White	22W	2065	20W	2622	30°	3000K	0,60	93,73
41921	Nero/Black	33W	3170	30W	3911	30°	3000K	0,80	121,54
41922	Bianco/White	33W	3170	30W	3911	30°	3000K	0,80	121,54

INSTALLAZIONE APPLICATION



Soffitto/Ceiling

DISEGNI TECNICI TECHNICAL DRAWINGS

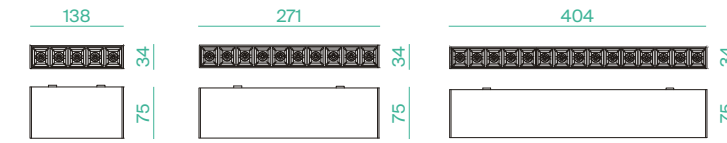

41917
41918

41919
41920

41921
41922

LUMIS_T



LED BRIDGELUX V8
CRI >90
PF 0,5
SDCM ≥3

CODE	FINISHING	WATT	LUMEN	WATT LIGHT SOURCE	LUMEN LIGHT SOURCE	BEAM	KELVIN	DRIVER	KG	PRICE
71962	Bianco/White	12W	1230	10,9W	1460	38°	3000K	30-42V/300mA	0,19	38,96
71963	Nero/Black	12W	1230	10,9W	1460	38°	3000K	30-42V/300mA	0,19	38,96

INSTALLAZIONE APPLICATION

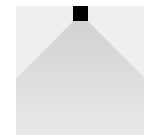

Soffitto/Ceiling

DISEGNI TECNICI TECHNICAL DRAWING

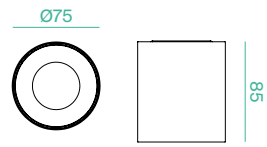

CYL SOFFITTO



LED BRIDGELUX
CRI >90
PF >0.5

CODE	FINISHING	WATT	LUMEN	WATT LIGHT SOURCE	LUMEN LIGHT SOURCE	BEAM	KELVIN	KG	PRICE
41706	Bianco/White	12W	890	12W	1680	55°	3000K	0,66	92,54
41705	Nero/Black	12W	890	12W	1680	55°	3000K	0,66	92,54

INSTALLAZIONE APPLICATION



Soffitto/Ceiling

DISEGNI TECNICI TECHNICAL DRAWINGS



LUMIS_Q



LED BRIDGELUX V8
CRI >90
PF 0,5
SDCM ≥3

CODE	FINISHING	WATT	LUMEN	WATT LIGHT SOURCE	LUMEN LIGHT SOURCE	BEAM	KELVIN	DRIVER	KG	PRICE
71964	Bianco/White	12W	1230	10,9W	1460	38°	3000K	30-42V/300mA	0,22	39,78
71965	Nero/Black	12W	1230	10,9W	1460	38°	3000K	30-42V/300mA	0,22	39,78

INSTALLAZIONE APPLICATION



Soffitto/Ceiling

DISEGNI TECNICI TECHNICAL DRAWING

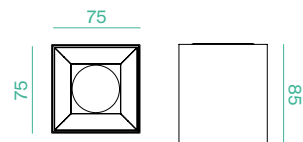

CYL_DICRO GU10 SOFFITTO



Lampadina esclusa / Bulb not included

CODE	FINISHING	BASE	VOLT	KG	PRICE
40762	Bianco/White	GU10	230V 50/60HZ	0,25	32,96
40763	Nero/Black	GU10	230V 50/60HZ	0,25	32,96

INSTALLAZIONE APPLICATION



Soffitto/Ceiling

DISEGNI TECNICI TECHNICAL DRAWINGS

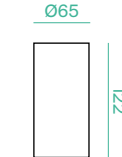

ALTAIR 9.8W SOFFITTO/PARETE



LED EPISTAR
CRI >90
PF >0.9

CODE	FINISHING	WATT	LUMEN	WATT LIGHT SOURCE	LUMEN LIGHT SOURCE	BEAM	KELVIN	MODE	KG	PRICE
42735	Bianco/White	9,8W	733	9,8W	940	36°	3000K	Dimm. Taglio di fase/ Phase cut dimming	0,36	78,98
42736	Nero/Black	9,8W	733	9,8W	940	36°	3000K	Dimm. Taglio di fase/ Phase cut dimming	0,36	78,98

INSTALLAZIONE APPLICATION



Soffitto/Ceiling



Parete/Wall

DISEGNI TECNICI TECHNICAL DRAWINGS

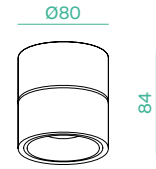

REGOLAZIONI ADJUSTABILITY



ALTAIR 14W SOFFITTO/PARETE

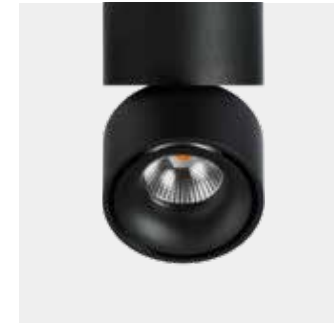

LED EPISTAR
CRI >90
PF >0.9

CODE	FINISHING	WATT	LUMEN	WATT LIGHT SOURCE	LUMEN LIGHT SOURCE	BEAM	KELVIN	MODE	KG	PRICE
42751	Bianco/White	14W	1050	14W	1400	36°	3000K	Dimm. Taglio di fase/ Phase cut dimming	0,67	91,13
42752	Nero/Black	14W	1050	14W	1400	36°	3000K	Dimm. Taglio di fase/ Phase cut dimming	0,67	91,13

INSTALLAZIONE APPLICATION

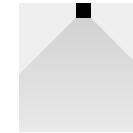

Soffitto/Ceiling

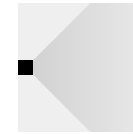

Parete/Wall

DISEGNI TECNICI TECHNICAL DRAWINGS

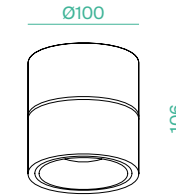

REGOLAZIONI ADJUSTABILITY



BOX DICRO



Lampadina esclusa / Bulb not included

CODE	FINISHING	BASE	WATT	VOLT	KG	PRICE
43166	Nero/Black	GU10	MAX 50W	100-240V	0,57	29,66
43167	Bianco/White	GU10	MAX 50W	100-240V	0,57	29,66

INSTALLAZIONE APPLICATION



Soffitto/Ceiling

DISEGNI TECNICI TECHNICAL DRAWINGS

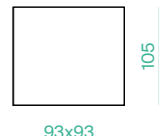

93x93

REGOLAZIONI ADJUSTABILITY



±30°



CONTAINER



Lampadina esclusa / Bulb not included

CODE	FINISHING	BASE	WATT	VOLT	SIZE	KG	PRICE
56900/230	Interno nero / Inside black	GU10	MAX 50W	100-240V	120x120x120	1,40	139,59
57900/230	Interno bianco / Inside white	GU10	MAX 50W	100-240V	120x120x120	1,40	139,59

INSTALLAZIONE APPLICATION



Soffitto/Ceiling

DISEGNI TECNICI TECHNICAL DRAWINGS

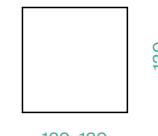

120x120

REGOLAZIONI ADJUSTABILITY



±45°



BOX 111



Lampadina esclusa / Bulb not included

CODE	FINISHING	BASE	WATT	VOLT	KG	PRICE
43164	Nero/Black	AR111 GU10	MAX 20W	100-240V	1,10	71,07
43165	Bianco/White	AR111 GU10	MAX 20W	100-240V	1,10	71,07

INSTALLAZIONE APPLICATION

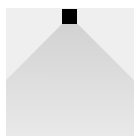

Soffitto/Ceiling

DISEGNI TECNICI TECHNICAL DRAWINGS

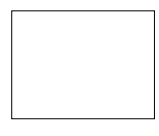

164x164

REGOLAZIONI ADJUSTABILITY



±30°



CONTAINER



Lampadina esclusa / Bulb not included

CODE	FINISHING	BASE	WATT	VOLT	SIZE	KG	PRICE
56901/230	Interno nero / Inside black	GU10	MAX 2x50W	100-240V	225x120x120	2,20	189,68
57901/230	Interno bianco / Inside white	GU10	MAX 2x50W	100-240V	225x120x120	2,20	189,68

INSTALLAZIONE APPLICATION



Soffitto/Ceiling

DISEGNI TECNICI TECHNICAL DRAWINGS

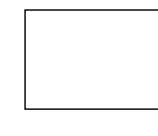

225x120

REGOLAZIONI ADJUSTABILITY



±45°



CONTAINER



Lampadina esclusa / Bulb not included

CODE	FINISHING	BASE	WATT	VOLT	SIZE	KG	PRICE
56902/230	Interno nero / Inside black	GU10	MAX 3x50W	100-240V	317x120x120	3,60	215,93
57902/230	Interno bianco / Inside white	GU10	MAX 3x50W	100-240V	317x120x120	3,60	215,93

INSTALLAZIONE APPLICATION



Soffitto/Ceiling

DISEGNI TECNICI TECHNICAL DRAWINGS

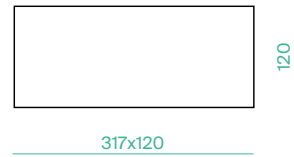

REGOLAZIONI ADJUSTABILITY



CONTAINER 111



Lampadina esclusa / Bulb not included

CODE	FINISHING	BASE	WATT	VOLT	SIZE	KG	PRICE
56904/230	Interno nero / Inside black	AR111 GU10	MAX 2x50W	100-240V	225x120x120	3,20	209,96
57904/230	Interno bianco / Inside white	AR111 GU10	MAX 2x50W	100-240V	225x120x120	3,20	209,96

INSTALLAZIONE APPLICATION

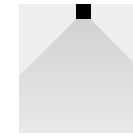

Soffitto/Ceiling

DISEGNI TECNICI TECHNICAL DRAWINGS



REGOLAZIONI ADJUSTABILITY



CONTAINER 111



Lampadina esclusa / Bulb not included

CODE	FINISHING	BASE	WATT	VOLT	SIZE	KG	PRICE
53903/230	Interno nero / Inside black	AR111 GU10	MAX 50W	100-240V	120x120x120	2,00	168,16
57903/230	Interno bianco / Inside white	AR111 GU10	MAX 50W	100-240V	120x120x120	2,00	168,16

INSTALLAZIONE APPLICATION



Soffitto/Ceiling

DISEGNI TECNICI TECHNICAL DRAWINGS

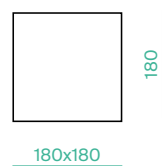

REGOLAZIONI ADJUSTABILITY



CONTAINER 111



Lampadina esclusa / Bulb not included

CODE	FINISHING	BASE	WATT	VOLT	SIZE	KG	PRICE
56905/230	Interno nero / Inside black	AR111 GU10	MAX 3x50W	100-240V	317x120x120	5,20	268,42
57905/230	Interno bianco / Inside white	AR111 GU10	MAX 3x50W	100-240V	317x120x120	5,20	268,42

INSTALLAZIONE APPLICATION



Soffitto/Ceiling

DISEGNI TECNICI TECHNICAL DRAWINGS



REGOLAZIONI ADJUSTABILITY



TORCIA_V



LED OSRAM
CRI >90
PF 0.95
SDCM 3

CODE	FINISHING	WATT	LUMEN 2700K	LUMEN 3000K	WATT LIGHT SOURCE	LUMEN LIGHT SOURCE 2700K	LUMEN LIGHT SOURCE 3000K	KELVIN	MODE	IP	KG	PRICE
41444	White Snow	6,6W	377	397	4,83	657	694	2700 /3000K	TRIAC	IP65	0,65	158,22
41445	Black Velvet	6,6W	377	397	4,83	657	694	2700 /3000K	TRIAC	IP65	0,65	158,22
41446	Royal Gold	6,6W	377	397	4,83	657	694	2700 /3000K	TRIAC	IP20	0,65	180,72
41447	Vintage Brass	6,6W	377	397	4,83	657	694	2700 /3000K	TRIAC	IP20	0,65	180,72
41448	White Snow	8,5W	529	546	6,43	966	995	2700 /3000K	TRIAC	IP65	0,70	169,25
41449	Black Velvet	8,5W	529	546	6,43	966	995	2700 /3000K	TRIAC	IP65	0,70	169,25
41450	Royal Gold	8,5W	529	546	6,43	966	995	2700 /3000K	TRIAC	IP20	0,70	191,75
41451	Vintage Brass	8,5W	529	546	6,43	966	995	2700 /3000K	TRIAC	IP20	0,70	191,75

INSTALLAZIONE APPLICATION



Parete/Wall

DISEGNI TECNICI TECHNICAL DRAWINGS

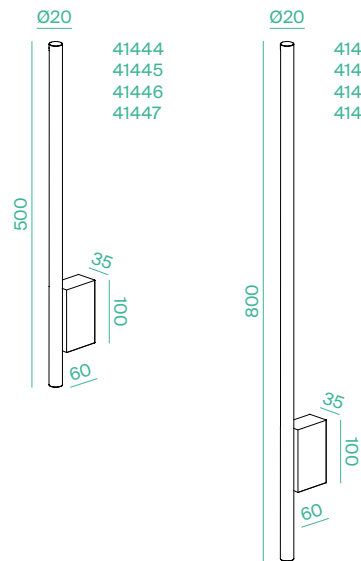

LED IP65 IP20 230V 50/60Hz CE

TORCIA_O



LED OSRAM
CRI >90
PF 0.96 15W / 0.97 21W
SDCM 3

CODE	FINISHING	WATT	LUMEN 2700K	LUMEN 3000K	WATT LIGHT SOURCE	LUMEN LIGHT SOURCE 2700K	LUMEN LIGHT SOURCE 3000K	KELVIN	MODE	IP	KG	PRICE
41452	White Snow	15W	1018	1040	11,85	1496	1576	2700 /3000K	TRIAC	IP65	0,90	168,44
41453	Black Velvet	15W	1018	1040	11,85	1496	1576	2700 /3000K	TRIAC	IP65	0,90	168,44
41454	Royal Gold	15W	1018	1040	11,85	1496	1576	2700 /3000K	TRIAC	IP20	0,90	190,94
41455	Vintage Brass	15W	1018	1040	11,85	1496	1576	2700 /3000K	TRIAC	IP20	0,90	190,94
41456	White Snow	21W	1430	1458	17,07	1923	2249	2700 /3000K	TRIAC	IP65	1,15	191,88
41457	Black Velvet	21W	1430	1458	17,07	1923	2249	2700 /3000K	TRIAC	IP65	1,15	191,88
41458	Royal Gold	21W	1430	1458	17,07	1923	2249	2700 /3000K	TRIAC	IP20	1,15	214,38
41459	Vintage Brass	21W	1430	1458	17,07	1923	2249	2700 /3000K	TRIAC	IP20	1,15	214,38

INSTALLAZIONE APPLICATION



Parete/Wall

DISEGNI TECNICI TECHNICAL DRAWINGS

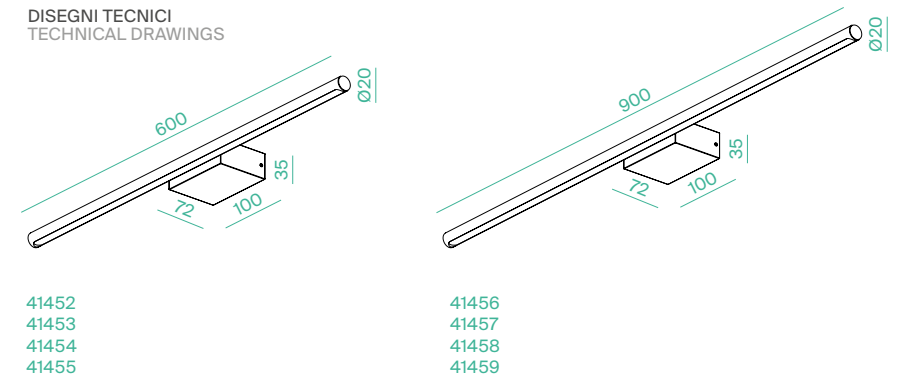

LED IP65 IP20 230V 50/60Hz CE

MINIMA



LED SMD-RUNLITE
 CRI >90
 PF >0.9
 SDCM 5

CODE	FINISHING	WATT	LUMEN	WATT LIGHT SOURCE	LUMEN LIGHT SOURCE	BEAM	KELVIN	MODE	KG	PRICE
42531	Bianco/White	14W	1190	9,94W	2583	107°	3000K	Dimm. Taglio di fase/Phase cut dimming	0,70	142,19
42532	Nero/Black	14W	1190	9,94W	2583	107°	3000K	Dimm. Taglio di fase/Phase cut dimming	0,70	142,19
42706	Bianco/White	18W	1570	12,96W	3240	107°	3000K	Dimm. Taglio di fase/Phase cut dimming	0,91	190,45
42707	Nero/Black	18W	1570	12,96W	3240	107°	3000K	Dimm. Taglio di fase/Phase cut dimming	0,91	190,45
42708	Bianco/White	24W	1920	17,71W	4428	107°	3000K	Dimm. Taglio di fase/Phase cut dimming	1,13	221,55
42709	Nero/Black	24W	1920	17,71W	4428	107°	3000K	Dimm. Taglio di fase/Phase cut dimming	1,13	221,55

INSTALLAZIONE APPLICATION



Parete/Wall

DISEGNI TECNICI TECHNICAL DRAWINGS

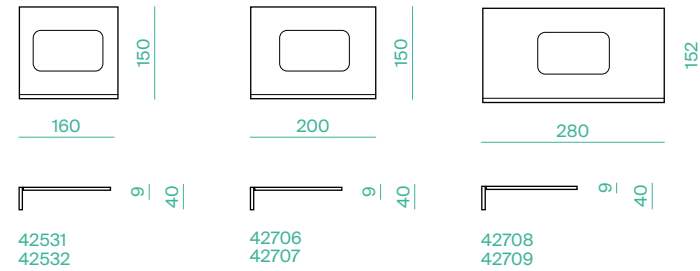

ESSENTIAL



LED LTWG
 CRI >90
 PF 0.9
 SDCM 3
 UGR <25

CODE	FINISHING	WATT	LUMEN	WATT LIGHT SOURCE	LUMEN LIGHT SOURCE	BEAM	KELVIN	MODE	KG	PRICE
43170	Bianco/White	20W	1209	18,9W	1620	110°	3000K	Dimm. Taglio di fase/Phase cut dimming	0,50	102,49
43171	Nero/Black	20W	1209	18,9W	1620	110°	3000K	Dimm. Taglio di fase/Phase cut dimming	0,50	102,49
43172	Bianco/White	30W	1850	28,29W	2432	110°	3000K	Dimm. Taglio di fase/Phase cut dimming	0,60	141,93
43173	Nero/Black	30W	1850	28,29W	2432	110°	3000K	Dimm. Taglio di fase/Phase cut dimming	0,60	141,93

INSTALLAZIONE APPLICATION



Parete/Wall

DISEGNI TECNICI TECHNICAL DRAWINGS

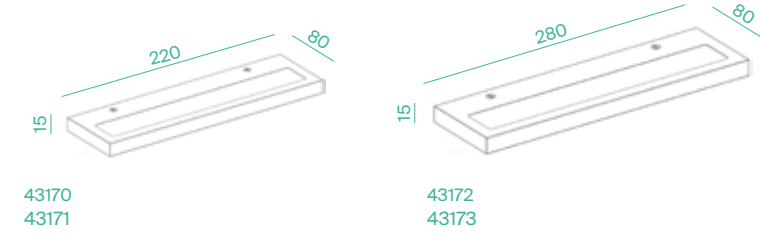

SU&GIU



LED LUMINUS CXM-6
CRI >90
PF 0.9
SDCM 3
UGR <25

CODE	FINISHING	WATT	LUMEN	WATT LIGHT SOURCE	LUMEN LIGHT SOURCE	BEAM	KELVIN	KG	PRICE
43174	Bianco/White	5W+5W	463+463	4,5W+4,5W	620+620	38°	3000K	0,70	119,38
43175	Nero/Black	5W+5W	463+463	4,5W+4,5W	620+620	38°	3000K	0,70	119,38

INSTALLAZIONE APPLICATION



Parete/Wall

DISEGNI TECNICI TECHNICAL DRAWINGS

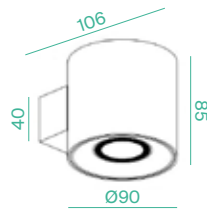

BLOC_EVO



LED SANAN
CRI >80
PF 0.5

CODE	FINISHING	WATT	LUMEN	WATT LIGHT SOURCE	LUMEN LIGHT SOURCE	KELVIN	DRIVER	KG	PRICE
40617	Nero/Black	11W	804	9W	1200	3000K	300mA 22-40V	0,66	76,98
40615	Bianco/White	11W	804	9W	1200	3000K	300mA 22-40V	0,66	76,98

INSTALLAZIONE APPLICATION



Parete/Wall

DISEGNI TECNICI TECHNICAL DRAWINGS

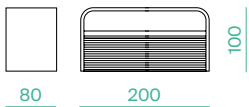

DUMBO FLEX



LED SEOUL SC
CRI >80
PF >0.5

CODE	FINISHING	WATT	LUMEN	WATT LIGHT SOURCE	LUMEN LIGHT SOURCE	KELVIN	DRIVER	VOLT	KG	PRICE
42619	Nero/Black	3W	150	2,76W	154	3000K	700mA	6V	0,30	62,22
42620	Cromo/Chrome	3W	150	2,76W	154	3000K	700mA	6V	0,30	66,11

INSTALLAZIONE APPLICATION



Parete/Wall

DISEGNI TECNICI TECHNICAL DRAWINGS

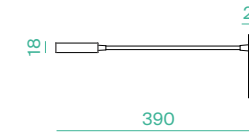

REGOLAZIONI ADJUSTABILITY



DUMBO

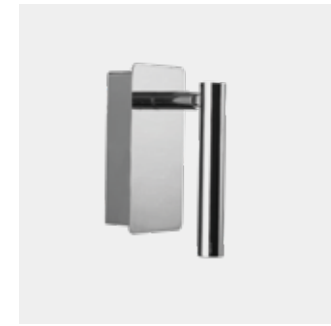

LED SEOUL SC
CRI >80
PF >0.5

CODE	FINISHING	WATT	LUMEN	WATT LIGHT SOURCE	LUMEN LIGHT SOURCE	KELVIN	DRIVER	VOLT	KG	PRICE
42621	Nero/Black	3W	150	2,76W	154	3000K	700mA	6V	0,26	54,45
42622	Cromo/Chrome	3W	150	2,76W	154	3000K	700mA	6V	0,26	58,33

INSTALLAZIONE APPLICATION



Parete/Wall

DISEGNI TECNICI TECHNICAL DRAWINGS

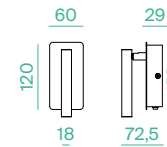

REGOLAZIONI ADJUSTABILITY



WALL INCASSO



CODE	FINISHING	DESCRIPRION	SIZE	KG	PRICE
21388	Bianco/White	Profilo /Profile	2mt	1,65	60,21

INSTALLAZIONE APPLICATION

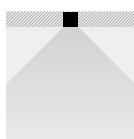

Incasso/Recessed

DISEGNI TECNICI TECHNICAL DRAWINGS



ONDA INCASSO



CODE	FINISHING	DESCRIPTION	SIZE	KG	PRICE
21385	Bianco/White	Profilo / Profile	2mt	1,80	60,96

INSTALLAZIONE APPLICATION

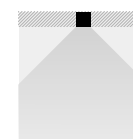

Incasso/Recessed

DISEGNI TECNICI TECHNICAL DRAWINGS

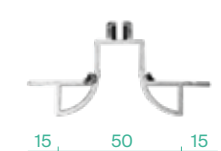

ACCESSORI ACCESSORIES



21301

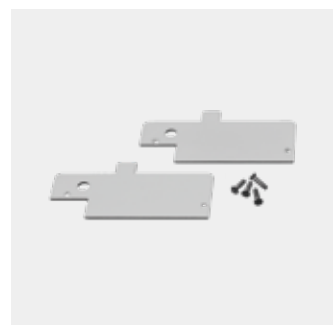

21389

CODE	FINISHING	DESCRIPTION	SIZE	PRICE
21301	Opale/Opal	Schermo / Diffuser	2mt	5,95
21389	Bianco/White	Kit 4 viti + 2 testate di chiusura/ 4 screws + 2 end caps kit		4,81

ACCESSORI ACCESSORIES



21387

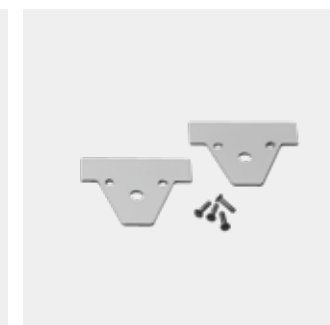

21386

CODE	FINISHING	DESCRIPTION	SIZE	PRICE
21387	Opale/Opal	Schermo / Diffuser	2mt	5,21
21386	Bianco/White	Kit 4 viti + 2 testate di chiusura/ 4 screws + 2 end caps kit		4,54

LINE_EVO
SOFFITTO

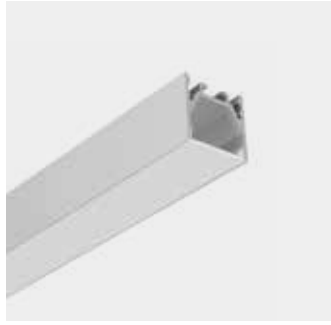

CODE	FINISHING	DESCRIPTION	SIZE	KG	PRICE
11911	Alluminio/ Aluminium	Profilo / Profile	2mt	1,20	29,96
11912	Bianco/White	Profilo / Profile	2mt	1,20	29,96
11913	Nero/Black	Profilo / Profile	2mt	1,20	29,96
11923	Oro/Gold	Profilo / Profile	2mt	1,20	29,96

INSTALLAZIONE
APPLICATION



Soffitto/Ceiling

DISEGNI TECNICI
TECHNICAL DRAWINGS

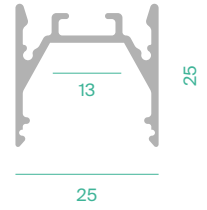

ACCESSORI
ACCESSORIES

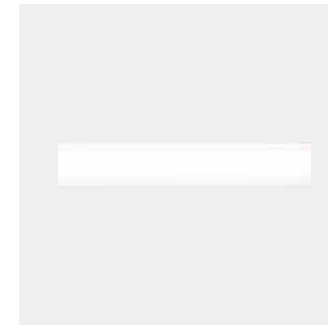

11914

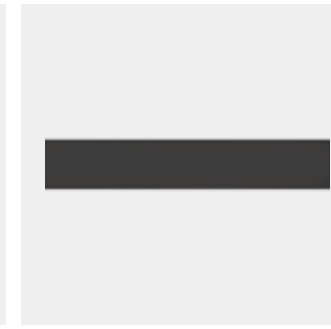

11915

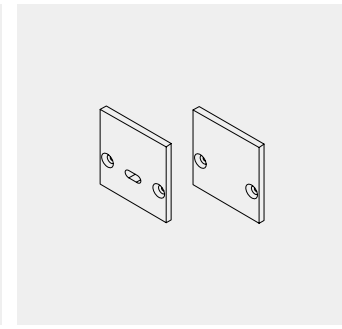

11916, 11917, 11918, 11924

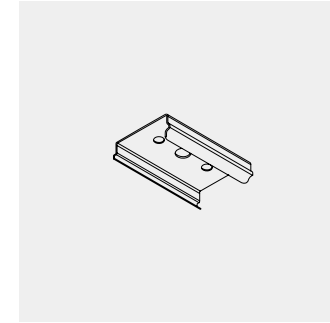

11919

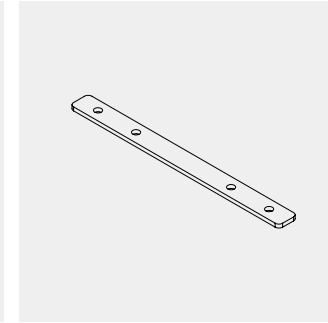

11920

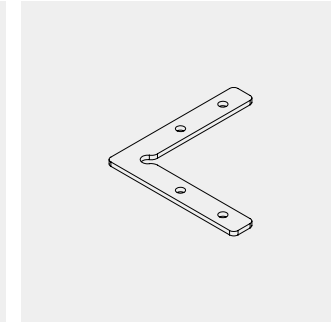

11921

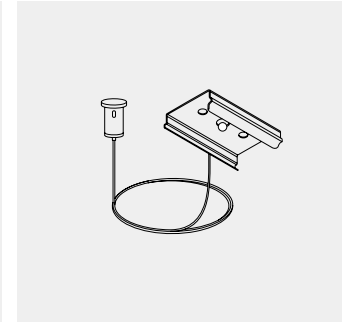

11922

CODE	FINISHING	DESCRIPTION	SIZE	PRICE
11914	Opale/Opal	Schermo / Diffuser	2mt	13,42
11915	Nero/Black	Schermo / Diffuser	2mt	13,42
11916	Alluminio/ Aluminium	Kit 4 viti + 2 testate di chiusura/4 screws + 2 end caps kit		8,36
11917	Bianco/White	Kit 4 viti + 2 testate di chiusura/4 screws + 2 end caps kit		8,36
11918	Nero/Black	Kit 4 viti + 2 testate di chiusura/4 screws + 2 end caps kit		8,36
11924	Oro/Gold	Kit 4 viti + 2 testate di chiusura/4 screws + 2 end caps kit		8,36
11919	n/a	Kit 2 staffe per soffitto/2 ceiling fixing brackets kit		3,09
11920	n/a	Congiunzione lineare/Linear junction		3,51
11921	n/a	Congiunzione 90°/90° junction		3,51
11922	n/a	Kit 2 sospensioni con cavo / 2 suspension kit with steel cable	3mt	16,78

LINE DEEP INCASSO



CODE	FINISHING	DESCRIPTION	SIZE	KG	PRICE
11910	Bianco/White	Profilo / Profile	2mt	1,30	33,05

INSTALLAZIONE APPLICATION

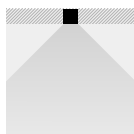

Incasso/Recessed

DISEGNI TECNICI TECHNICAL DRAWINGS

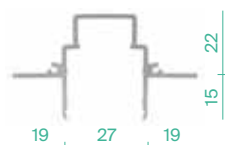

ACCESSORI ACCESSORIES



21303

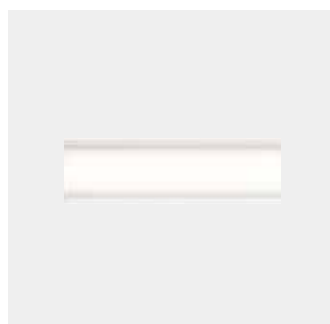

21304

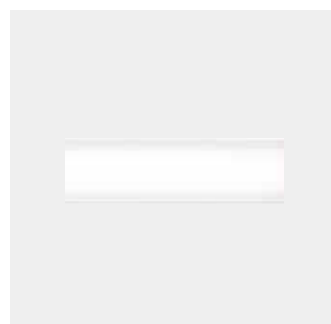

21305

CODE	FINISHING	DESCRIPTION	SIZE	PRICE
21303	Trasparente/ Transparent	Schermo / Diffuser	2mt	7,13
21304	Satinato/Frosted	Schermo / Diffuser	2mt	9,24
21305	Opale/Opal	Schermo / Diffuser	2mt	7,13

LINE INCASSO



CODE	FINISHING	DESCRIPTION	SIZE	KG	PRICE
11906	Alluminio/Aluminium	Profilo / Profile	2mt	1,30	33,05

INSTALLAZIONE APPLICATION

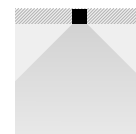

Incasso/Recessed

DISEGNI TECNICI TECHNICAL DRAWINGS

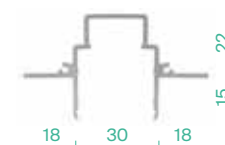

ACCESSORI ACCESSORIES

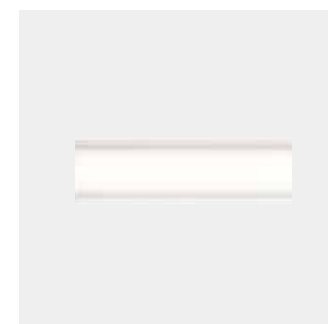

11675

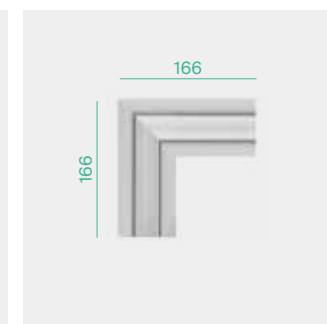

13570

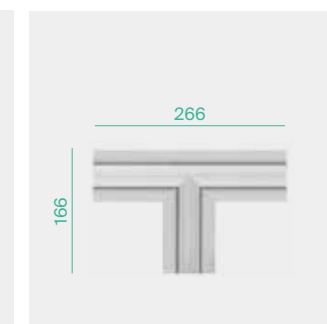

13571

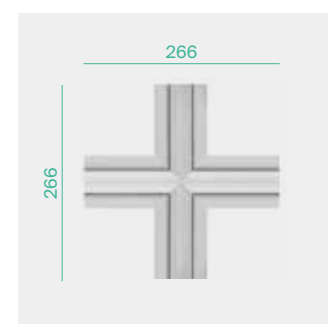

13572

CODE	FINISHING	DESCRIPTION	SIZE	PRICE
11675	Satinato-opale/ Opal-frosted	Schermo / Diffuser	2mt	21,69
13570	Alluminio/ Aluminium	Giunto "L"/L-Joint		36,77
13571	Alluminio/ Aluminium	Giunto "T"/T-Joint		45,44
13572	Alluminio/ Aluminium	Giunto "X"/X-Joint		53,29

LINE MINI SOFFITTO



CODE	FINISHING	DESCRIPTION	SIZE	KG	PRICE
11925	Alluminio/Aluminium	Profilo + diffusore opale / Profile + opal diffuser	2mt	0,14	14,25

INSTALLAZIONE APPLICATION



Soffitto/Ceiling

DISEGNI TECNICI TECHNICAL DRAWINGS

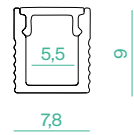

ACCESSORI ACCESSORIES

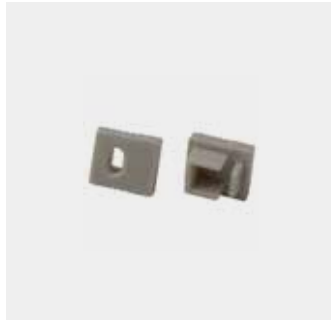

11926



11927

CODE	DESCRIPTION	PRICE
11926	Kit testate di chiusura aperta e chiusa (2pz) / Open and closed end-cap (2 pcs)	1,50
11927	Kit clips di fissaggio (2pz) / Fixing brackets (2 pcs)	1,50

DOUBLE SOFFITTO



CODE	FINISHING	DESCRIPTION	SIZE	KG	PRICE
21472	Alluminio/Aluminium	Profilo / Profile	2mt	0,30	22,12
21473	Bianco/White	Profilo / Profile	2mt	0,30	25,07

INSTALLAZIONE APPLICATION



Soffitto/Ceiling

DISEGNI TECNICI TECHNICAL DRAWINGS

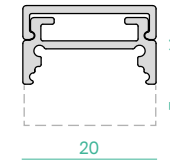

ACCESSORI ACCESSORIES



21476 - 21477

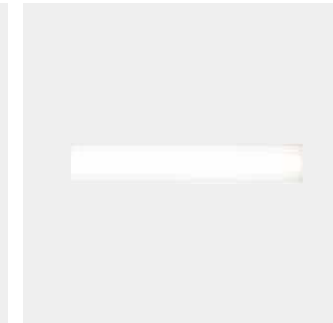

21474

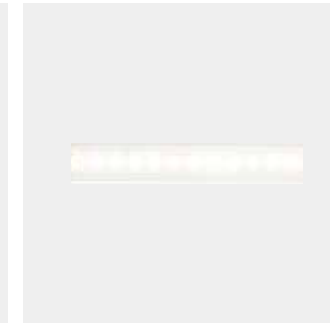

21475

CODE	FINISHING	DESCRIPTION	SIZE	PRICE
21474	Opale/Opal	Schermo / Diffuser	2mt	7,03
21475	Satinato/Frosted	Schermo / Diffuser	2mt	9,70
21476	Alluminio/Aluminium	Kit 4 viti + 2 testate / 4 screws + 2 end caps kit		0,98
21477	Bianco/White	Kit 4 viti + 2 testate / 4 screws + 2 end caps kit		2,55

PR1 SOFFITTO



PR1_DEEP SOFFITTO



CODE	FINISHING	DESCRIPTION	SIZE	KG	PRICE
21048	Alluminio/Aluminium	Profilo / Profile	2mt	0,20	10,84
21376	Bianco/White	Profilo / Profile	2mt	0,20	13,92

CODE	FINISHING	DESCRIPTION	SIZE	KG	PRICE
21494	Alluminio/Aluminium	Profilo / Profile	2mt	0,40	19,49
21495	Bianco/White	Profilo / Profile	2mt	0,40	22,95

INSTALLAZIONE APPLICATION

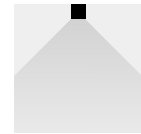

Soffitto/Ceiling

DISEGNI TECNICI TECHNICAL DRAWINGS

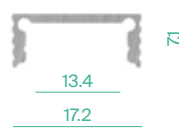

INSTALLAZIONE APPLICATION

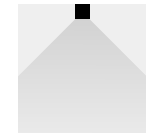

Soffitto/Ceiling

DISEGNI TECNICI TECHNICAL DRAWINGS

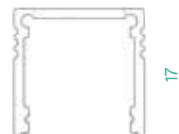

ACCESSORI ACCESSORIES

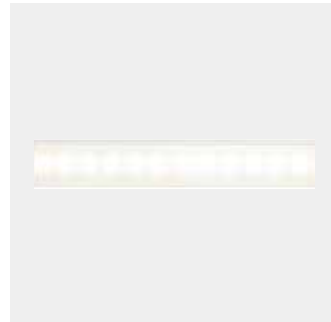

21052

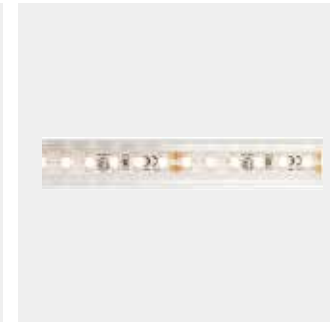

21051

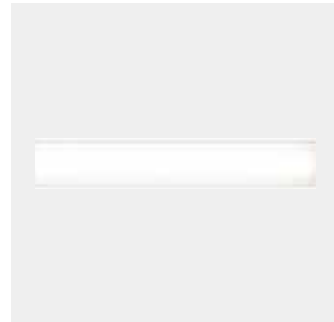

21301

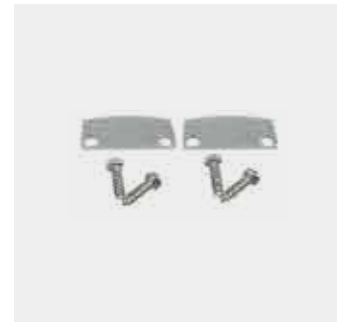

21053 - 21378



21496 - 21497



21054 - 21379

CODE	FINISHING	DESCRIPTION	SIZE	PRICE
21052	Satinato/Frosted	Schermo per PR1, PR1_DEEP/ Diffuser for PR1, PR1_DEEP	2mt	7,91
21051	Trasparente/Transparent	Schermo per PR1, PR1_DEEP/ Diffuser for PR1, PR1_DEEP	2mt	5,95
21301	Opale/Opal	Schermo per PR1, PR1_DEEP/ Diffuser for PR1, PR1_DEEP	2mt	5,95
21053	Alluminio/Aluminium	Kit 4 viti + 2 testate per PR1 / 4 screws + 2 end caps kit for PR1		0,84
21378	Bianco/White	Kit 4 viti + 2 testate per PR1 / 4 screws + 2 end caps kit for PR1		2,42
21496	Alluminio/Aluminium	Kit 4 viti + 2 testate per PR1_DEEP / 4 screws + 2 end caps kit for PR1_DEEP		2,49
21497	Bianco/White	Kit 4 viti + 2 testate per PR1_DEEP / 4 screws + 2 end caps kit for PR1_DEEP		3,39
21054	Alluminio/Aluminium	Kit 2 staffe fissaggio per PR1, PR1_DEEP/ 2 fixing brackets kit for PR1, PR1_DEEP		0,57
21379	Bianco/White	Kit 2 staffe fissaggio per PR1, PR1_DEEP/ 2 fixing brackets kit for PR1, PR1_DEEP		2,04

PR2 INCASSO



PR2_DEEP INCASSO



CODE	FINISHING	DESCRIPTION	SIZE	KG	PRICE
21049	Alluminio/Aluminium	Profilo / Profile	2mt	0,22	11,82
21377	Bianco/White	Profilo / Profile	2mt	0,22	14,68

CODE	FINISHING	DESCRIPTION	SIZE	KG	PRICE
21498	Alluminio/Aluminium	Profilo / Profile	2mt	0,44	29,42
21499	Bianco/White	Profilo / Profile	2mt	0,44	33,04

INSTALLAZIONE APPLICATION



Incasso/Recessed

DISEGNI TECNICI TECHNICAL DRAWINGS

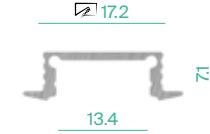

INSTALLAZIONE APPLICATION



Incasso/Recessed

DISEGNI TECNICI TECHNICAL DRAWINGS

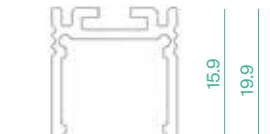

ACCESSORI ACCESSORIES

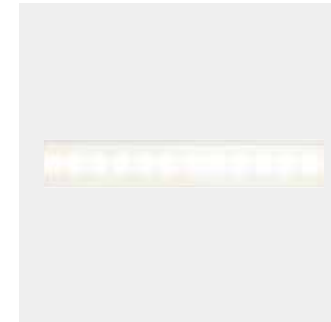

21052

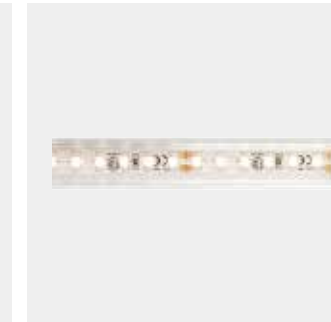

21051



21301



21053 - 21378



21496 - 21497



21054 - 21379



21500

CODE	FINISHING	DESCRIPTION	SIZE	PRICE
21052	Satinato/Frosted	Schermo per PR2, PR2_DEEP/ Diffuser for PR2, PR2_DEEP	2mt	7,91
21051	Trasparente/Transparent	Schermo per PR2, PR2_DEEP/ Diffuser for PR2, PR2_DEEP	2mt	5,95
21301	Opale/Opal	Schermo per PR2, PR2_DEEP/ Diffuser for PR2, PR2_DEEP	2mt	5,95
21053	Alluminio/Aluminium	Kit 4 viti + 2 testate per PR2/ 4 screws + 2 end caps kit for PR2		0,84
21378	Bianco/White	Kit 4 viti + 2 testate per PR2/ 4 screws + 2 end caps kit for PR2		2,42
21496	Alluminio/Aluminium	Kit 4 viti + 2 testate per PR2_DEEP/ 4 screws + 2 end caps kit for PR2_DEEP		2,49
21497	Bianco/White	Kit 4 viti + 2 testate per PR2_DEEP/ 4 screws + 2 end caps kit for PR2_DEEP		3,39
21054	Alluminio/Aluminium	Kit 2 staffe fissaggio per PR2, PR2_DEEP/ 2 fixing brackets kit for PR2, PR2_DEEP		0,57
21379	Bianco/White	Kit 2 staffe fissaggio per PR2, PR2_DEEP/ 2 fixing brackets kit for PR2, PR2_DEEP		2,04
21500	n/a	Molla per PR2_DEEP 2pz/Spring for PR2_DEEP 2pcs		5,50

PR3_EVO ANGOLO



CODE	FINISHING	DESCRIPTION	SIZE	KG	PRICE
21440	Alluminio/Aluminium	Profilo / Profile	2mt	0,30	16,18
21441	Bianco/White	Profilo / Profile	2mt	0,30	18,22

INSTALLAZIONE APPLICATION



Angolo/Corner

DISEGNI TECNICI TECHNICAL DRAWINGS

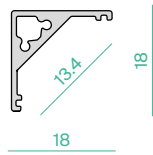

ACCESSORI ACCESSORIES



21442



21443



21444 - 21445



21446 - 21447

CODE	FINISHING	DESCRIPTION	SIZE	PRICE
21442	Satinato/Frosted	Schermo / Diffuser	2mt	8,87
21443	Opale/Opal	Schermo / Diffuser	2mt	6,41
21444	Alluminio/Aluminium	Kit 4 viti + 2 testate per PR3 EVO/4 screws + 2 end caps kit for PR3 EVO		0,98
21445	Bianco/White	Kit 4 viti + 2 testate per PR3 EVO/4 screws + 2 end caps kit for PR3 EVO		2,79
21446	Alluminio/Aluminium	Kit 2 staffe fissaggio per PR3 EVO/2 fixing brackets kit for PR3 EVO		1,06
21447	Bianco/White	Kit 2 staffe fissaggio per PR3 EVO/2 fixing brackets kit for PR3 EVO		2,26

TWIGGY_LESS



LED OSRAM
CRI >80

Ricarica con base di appoggio wireless con alimentatore (compreso)
Charging through wireless base with charger (included)

CODE	FINISHING	WATT	LUMEN	WATT LIGHT SOURCE	LUMEN LIGHT SOURCE	BEAM	KELVIN	KG	PRICE
42753	Antracite/Anthracite	2.2W	150	1.8W	217	100°	2700/3000K	0,85	103,30
42754	Bianco/White	2.2W	150	1.8W	217	100°	2700/3000K	0,85	103,30
42755	Nero/Black	2.2W	150	1.8W	217	100°	2700/3000K	0,85	103,30
42756	Corten	2.2W	150	1.8W	217	100°	2700/3000K	0,85	103,30
42757	Giallo/Yellow	2.2W	150	1.8W	217	100°	2700/3000K	0,85	103,30
42758	Arancione/Orange	2.2W	150	1.8W	217	100°	2700/3000K	0,85	103,30
42759	Verde Salvia/Sage Green	2.2W	150	1.8W	217	100°	2700/3000K	0,85	103,30
42760	Blu Avio	2.2W	150	1.8W	217	100°	2700/3000K	0,85	103,30
42761	Sabbia/Sand	2.2W	150	1.8W	217	100°	2700/3000K	0,85	103,30
42820	Rosso Rubino/Ruby Red	2.2W	150	1.8W	217	100°	2700/3000K	0,85	103,30

INSTALLAZIONE APPLICATION

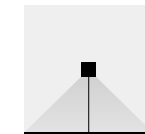

Appoggio/Standing

DISEGNI TECNICI TECHNICAL DRAWINGS

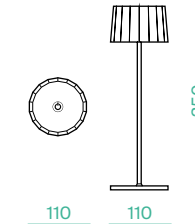

La garanzia fornita dalla casa sulla batteria è di 12 mesi
/Manufacturer's warranty on battery is 12 months

ACCESSORI ACCESSORIES

CODE	DESCRIPTION	Alimentazione/AC-DC Adaptor	PRICE
11654	Base ricarica multipla x6 lampade Multiple charger x6 lamps	100-240V 50/60Hz 9VDC 5A 45W	157,97

DISEGNI TECNICI TECHNICAL DRAWINGS

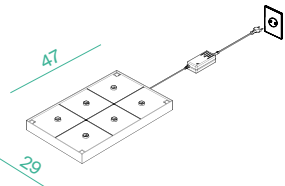

DIogene



LED OSRAM
CRI >80

Ricarica con cavo USB-C
con alimentatore (compreso)
Charging through USB-C cable
with charger (included)

CODE	FINISHING	WATT	LUMEN	WATT LIGHT SOURCE	LUMEN LIGHT SOURCE	BEAM	KELVIN	KG	PRICE
42720	Antracite/ Anthracite	2.2W	200	1.8W	205	120°	2700/3000K	1,60	120,30
42721	Bianco/White	2.2W	200	1.8W	205	120°	2700/3000K	1,60	120,30
42722	Nero/Black	2.2W	200	1.8W	205	120°	2700/3000K	1,60	120,30
42723	Corten	2.2W	200	1.8W	205	120°	2700/3000K	1,60	120,30
42762	Sabbia/Sand	2.2W	200	1.8W	205	120°	2700/3000K	1,60	120,30

INSTALLAZIONE APPLICATION



Appoggio/Standing

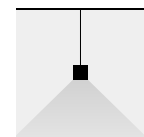

Sospesa/Hanging

DISEGNI TECNICI TECHNICAL DRAWINGS

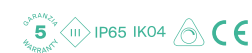
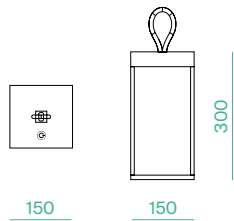

La garanzia fornita dalla casa sulla batteria è di 12 mesi
/Manufacturer's warranty on battery is 12 months

DIogene L



LED OSRAM
CRI >80

Ricarica con cavo USB-C
con alimentatore (compreso)
Charging through USB-C cable
with charger (included)

CODE	FINISHING	WATT	LUMEN	WATT LIGHT SOURCE	LUMEN LIGHT SOURCE	BEAM	KELVIN	KG	PRICE
42724	Antracite/ Anthracite	2.2W	200	1.8W	205	120°	2700/3000K	1,80	131,24
42725	Bianco/White	2.2W	200	1.8W	205	120°	2700/3000K	1,80	131,24
42726	Nero/Black	2.2W	200	1.8W	205	120°	2700/3000K	1,80	131,24
42727	Corten	2.2W	200	1.8W	205	120°	2700/3000K	1,80	131,24
42763	Sabbia/Sand	2.2W	200	1.8W	205	120°	2700/3000K	1,80	131,24

INSTALLAZIONE APPLICATION

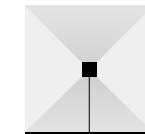

Appoggio/Standing

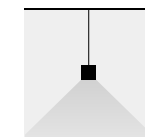

Sospesa/Hanging

DISEGNI TECNICI TECHNICAL DRAWINGS

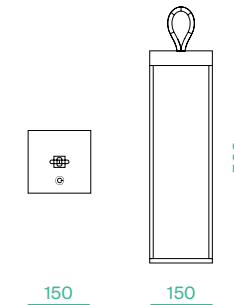

La garanzia fornita dalla casa sulla batteria è di 12 mesi /
Manufacturer's warranty on battery is 12 months

IOTA



LED OSRAM
CRI >80

Ricarica con cavo USB-C con alimentatore (compreso) / Charging through USB-C cable with charger (included)

CODE	FINISHING	WATT	LUMEN	WATT LIGHT SOURCE	LUMEN LIGHT SOURCE	BEAM	KELVIN	KG	PRICE
42800	Antracite/Dark Grey	2.5W	120	1.8W	200	120°	2700/3000K	0,75	103,95
42801	Bianco/Matt White	2.5W	120	1.8W	200	120°	2700/3000K	0,75	103,95
42802	Nero/Matt Black	2.5W	120	1.8W	200	120°	2700/3000K	0,75	103,95
42803	Sabbia/Sand	2.5W	120	1.8W	200	120°	2700/3000K	0,75	103,95
42804	Rosso Rubino/Ruby Red	2.5W	120	1.8W	200	120°	2700/3000K	0,75	103,95
42805	Verde Salvia/Sage Green	2.5W	120	1.8W	200	120°	2700/3000K	0,75	103,95
42806	Blu Oceano/Ocean Blue	2.5W	120	1.8W	200	120°	2700/3000K	0,75	103,95
42807	Corten	2.5W	120	1.8W	200	120°	2700/3000K	0,75	103,95

INSTALLAZIONE APPLICATION

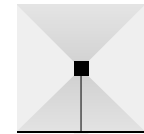

Appoggio/Standing

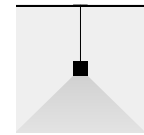

Sospesa/Hanging

DISEGNI TECNICI TECHNICAL DRAWINGS

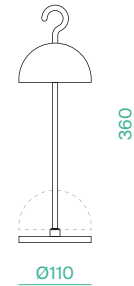

ZEN



LED OSRAM
CRI >80

Ricarica con base di appoggio wireless con alimentatore (compreso) / Charging through wireless base with charger (included)

CODE	FINISHING	WATT	LUMEN	WATT LIGHT SOURCE	LUMEN LIGHT SOURCE	BEAM	KELVIN	KG	PRICE
42794	Bianco/Matt White	2.5W	120	1.7W	206	120°	2700/3000K	0,55	114,45
42795	Sabbia/Sand	2.5W	120	1.7W	206	120°	2700/3000K	0,55	114,45
42796	Cromo/Chrome	2.5W	120	1.7W	206	120°	2700/3000K	0,55	171,15
42799	Grigio Siderale/Space Grey	2.5W	120	1.7W	206	120°	2700/3000K	0,55	171,15

INSTALLAZIONE APPLICATION

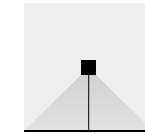

Appoggio/Standing

DISEGNI TECNICI TECHNICAL DRAWINGS

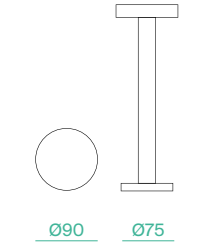

5 YEAR WARRANTY IP65 IK04 CE

La garanzia fornita dalla casa sulla batteria è di 12 mesi / Manufacturer's warranty on battery is 12 months

5 YEAR WARRANTY IP65 IK04 CE

La garanzia fornita dalla casa sulla batteria è di 12 mesi / Manufacturer's warranty on battery is 12 months

ACCESSORI ACCESSORIES

CODE	DESCRIPTION	Alimentazione/AC-DC Adaptor	PRICE
11654	Base ricarica multipla x6 lampade / Multiple charger x6 lamps	100-240V 50/60Hz 9VDC 5A 45W	157,97

DISEGNI TECNICI TECHNICAL DRAWINGS

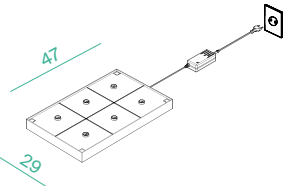



CODE	DESCRIPTION	PRICE
11371	Espositore lampade wireless / Display cabinet for wireless lamps	82,40

SLICE PARETE



LED BRIDGELUX
CRI >80
PF >0.5

CODE	FINISHING	WATT	LUMEN	WATT LIGHT SOURCE	LUMEN LIGHT SOURCE	BEAM	KELVIN	KG	PRICE
41292	Bianco/White	3,5W+3,5W	263+263	2,9W+ 2,9W	360+360	90°	3000K	0,36	38,63
41293	Bianco/White	5W+5W	343+343	4,6W+ 4,6W	500+500	90°	3000K	0,51	45,84
41290	Nero/Black	3,5W+3,5W	263+263	2,9W+ 2,9W	360+360	90°	3000K	0,36	38,63
41291	Nero/Black	5W+5W	343+343	4,6W+ 4,6W	500+500	90°	3000K	0,51	45,84

INSTALLAZIONE
APPLICATION



Parete/Wall

DISEGNI TECNICI
TECHNICAL DRAWINGS

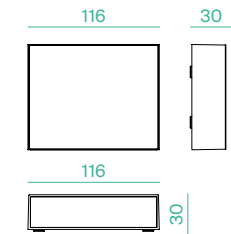

41292
41290

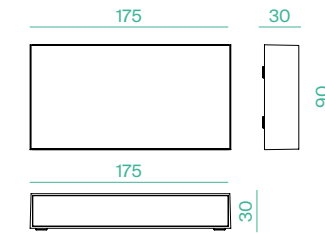

41293
41291



LOGICA

TITANO EVO PARETE MONO-EMISSIONE

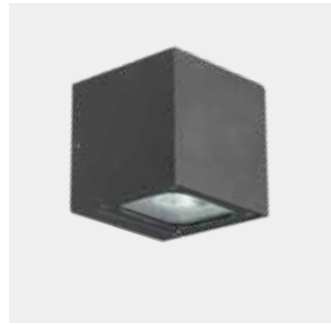

LED EDISON
CRI >80
PF 0.54 (6W)
0.91 (10W)

CODE	FINISHING	WATT	LUMEN	WATT LIGHT SOURCE	LUMEN LIGHT SOURCE	BEAM	KELVIN	DRIVER	KG	PRICE
43126	Bianco/White	6W	300	4,6W	437	45°	3000K	500mA, 23V	0,85	81,12
43130	Antracite/Anthracite	6W	300	4,6W	437	45°	3000K	500mA, 23V	0,85	81,12
43127	Bianco/White	6W	310	4,7W	448	45°	5000K	500mA, 23V	0,85	81,12
43131	Antracite/Anthracite	6W	310	4,7W	448	45°	5000K	500mA, 23V	0,85	81,12
43128	Bianco/White	10W	700	9W	811	60°	3000K	250mA, 58V	1,4	104,82
43132	Antracite/Anthracite	10W	700	9W	811	60°	3000K	250mA, 58V	1,4	104,82
43129	Bianco/White	10W	720	9,1W	834	60°	5000K	250mA, 58V	1,4	104,82
43133	Antracite/Anthracite	10W	720	9,1W	834	60°	5000K	250mA, 58V	1,4	104,82

INSTALLAZIONE APPLICATION



Parete/Wall

DISEGNI TECNICI TECHNICAL DRAWINGS

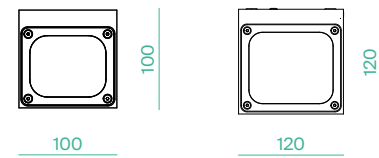

43126
43127
43130
43131

43128
43129
43132
43133

TITANO EVO PARETE BI-EMISSIONE



LED EDISON
CRI >80
PF 0.57 (2X6W)
0.92 (2X10W)

CODE	FINISHING	WATT	LUMEN	WATT LIGHT SOURCE	LUMEN LIGHT SOURCE	BEAM	KELVIN	DRIVER	KG	PRICE
43134	Bianco / White	6W+6W	300+300	4,6W+ 4,6W	437+437	45°	3000K	500mA, 24V 30V	0,93	92,06
43138	Antracite / Anthracite	6W+6W	300+300	4,6W+ 4,6W	437+437	45°	3000K	500mA, 24V 30V	0,93	92,06
43135	Bianco / White	6W+6W	310+310	4,7W+ 4,7W	448+448	45°	5000K	500mA, 24V 30V	0,93	92,06
43139	Antracite / Anthracite	6W+6W	310+310	4,7W+ 4,7W	448+448	45°	5000K	500mA, 24V 30V	0,93	92,06
43136	Bianco / White	10W+10W	700+700	9W+9W	811+811	60°	3000K	250mA, 98V	1,6	123,04
43140	Antracite / Anthracite	10W+10W	700+700	9W+9W	811+811	60°	3000K	250mA, 98V	1,6	123,04
43137	Bianco/ White	10W+10W	720+720	9,1W+9,1W	834+834	60°	5000K	250mA, 98V	1,6	123,04
43143	Antracite/ Anthracite	10W+10W	720+720	9,1W+9,1W	834+834	60°	5000K	250mA, 98V	1,6	123,04

INSTALLAZIONE APPLICATION



Parete/Wall

DISEGNI TECNICI TECHNICAL DRAWINGS

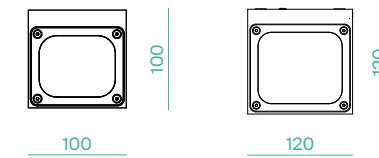

43134
43135
43138
43139

43136
43137
43140
43143

TITANO EVO PALO



Corpo luminoso non incluso
Lighting source not included

CODE	FINISHING	DESCRIPTION	SIZE	KG	PRICE
40580	Antracite/ Anthracite	Accessorio c/griglie antiabbagliamento/ Accessory with anti-glaring grid	120x120x580	2,20	103,30
40579	Antracite/ Anthracite	Accessorio c/griglie antiabbagliamento/ Accessory with anti-glaring grid	100x100x500	1,40	78,98

INSTALLAZIONE APPLICATION



Terra/Floor

DISEGNI TECNICI TECHNICAL DRAWINGS

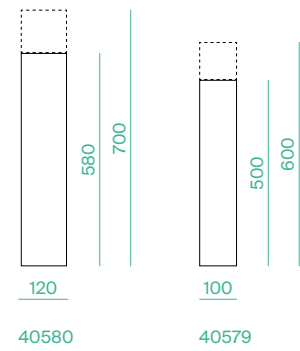

TITANO EVO SOFFITTO



LED EDISON
CRI >80
PF 0.54 (6W)
0.91 (10W)

CODE	FINISHING	WATT	LUMEN	WATT LIGHT SOURCE	LUMEN LIGHT SOURCE	BEAM	KELVIN	DRIVER	KG	PRICE
43144	Bianco/ White	6W	300	4,6W	437	45°	3000K	500mA, 23V	0,85	81,12
43148	Antracite/ Anthracite	6W	300	4,6W	437	45°	3000K	500mA, 23V	0,85	81,12
43145	Bianco/ White	6W	310	4,7W	448	45°	5000K	500mA, 23V	0,85	81,12
43149	Antracite/ Anthracite	6W	310	4,7W	448	45°	5000K	500mA, 23V	0,85	81,12
43146	Bianco/ White	10W	700	9W	811	60°	3000K	250mA, 58V	1,40	104,82
43150	Antracite/ Anthracite	10W	700	9W	811	60°	3000K	250mA, 58V	1,40	104,82
43147	Bianco/ White	10W	720	9,1W	834	60°	5000K	250mA, 58V	1,40	104,82
43151	Antracite/ Anthracite	10W	720	9,1W	834	60°	5000K	250mA, 58V	1,40	104,82

INSTALLAZIONE APPLICATION

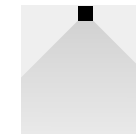

Soffitto/Ceiling

DISEGNI TECNICI TECHNICAL DRAWINGS

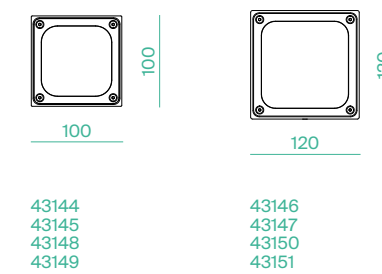

3 YEAR WARRANTY LED IP54 IK08 230V 50/60Hz CE

MOONLIGHT PALO



LED RF2835
CRI 80
PF 0.9

CODE	FINISHING	WATT	LUMEN	WATT LIGHT SOURCE	LUMEN LIGHT SOURCE	BEAM	KELVIN	DRIVER	KG	PRICE
41167	Antracite/ Anthracite	10W	700	9,5W	1200	90°	3000K	250VDC/ 32mA	1,30	72,91
41168	Antracite/ Anthracite	15W	1050	14,5W	1650	90°	3000K	250VDC/ 48mA	1,60	103,30
41169	Antracite/ Anthracite	20W	1400	19,5W	2120	100°	3000K	250VDC/ 64mA	2,00	168,91

INSTALLAZIONE APPLICATION



Terra/Floor

DISEGNI TECNICI TECHNICAL DRAWINGS

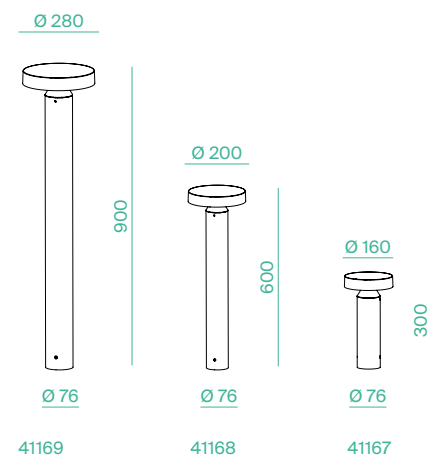

MOONLIGHT PARETE



LED RF2835
CRI 80
PF 0.9

CODE	FINISHING	WATT	LUMEN	WATT LIGHT SOURCE	LUMEN LIGHT SOURCE	BEAM	KELVIN	DRIVER	KG	PRICE
41166	Antracite/ Anthracite	15W	1050	14,5W	1650	90°	3000K	250VDC/48mA	0,90	75,33

INSTALLAZIONE APPLICATION



Parete/Wall

DISEGNI TECNICI TECHNICAL DRAWINGS

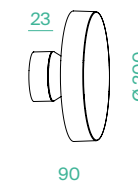

ACCESSORI ACCESSORIES



CODE	FINISHING	DESCRIPTION	PRICE
11554	Antracite/ Anthracite	Distanziale per parete / Wall mounting spacer	11,67



FOS PALO



LED RF2835
CRI 80
PF 0.9

CODE	FINISHING	WATT	LUMEN	WATT LIGHT SOURCE	LUMEN LIGHT SOURCE	BEAM	KELVIN	DRIVER	KG	PRICE
41165	Antracite/ Anthracite	8W	650	6,4W	860	120°	3000K	250VDC/48mA	1,70	125,17

INSTALLAZIONE APPLICATION



Terra/Floor

DISEGNI TECNICI TECHNICAL DRAWINGS

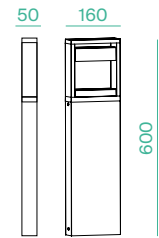

REGOLAZIONI ADJUSTABILITY



COMBI_EVO



LED BRIDGELUX
CRI >80
PF >0.5

CODE	FINISHING	WATT	LUMEN	WATT LIGHT SOURCE	LUMEN LIGHT SOURCE	BEAM	KELVIN	DRIVER	KG	PRICE
43168	Bianco/White	5W+5W	445+445	4,5W+4,5W	563+563	0-90°	3000K	300mA 100-240V	0,64	87,50
43169	Nero/Black	5W+5W	445+445	4,5W+4,5W	563+563	0-90°	3000K	300mA 100-240V	0,64	87,50

INSTALLAZIONE APPLICATION



Parete/Wall

DISEGNI TECNICI TECHNICAL DRAWINGS

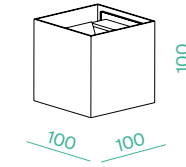

REGOLAZIONI ADJUSTABILITY



FOS PARETE



LED RF2835
CRI 80
PF 0.9

CODE	FINISHING	WATT	LUMEN	WATT LIGHT SOURCE	LUMEN LIGHT SOURCE	BEAM	KELVIN	DRIVER	KG	PRICE
41164	Antracite/ Anthracite	8W	650	6,4W	860	120°	3000K	250VDC/48mA	1,10	77,78

INSTALLAZIONE APPLICATION

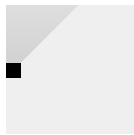

Parete/Wall

DISEGNI TECNICI TECHNICAL DRAWINGS

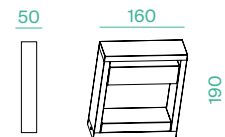

REGOLAZIONI ADJUSTABILITY

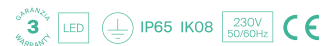

DARDO



CODE	FINISHING	WATT	LUMEN	WATT LIGHT SOURCE	LUMEN LIGHT SOURCE	BEAM	KELVIN	KG	PRICE
42790	Antracite/ Anthracite	6W	320	4,2W	397	30°	3000K	1,20	101,23

INSTALLAZIONE APPLICATION

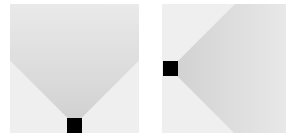

Terra/Floor

Parete/Wall

DISEGNI TECNICI TECHNICAL DRAWINGS

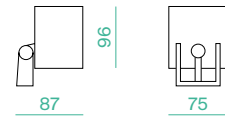

REGOLAZIONI ADJUSTABILITY



ACCESSORI ACCESSORIES



42791



42792

CODE	DESCRIPTION	PRICE
42791	Accessorio anti-glare/Anti-glare accessory	10,94
42792	Accessorio picchetto in plastica/Plastic spike accessory	7,80

SKORPIO S



LED COB EDISON
CRI >80
PF 0.5

CODE	FINISHING	WATT	LUMEN	WATT LIGHT SOURCE	LUMEN LIGHT SOURCE	BEAM	KELVIN	KG	PRICE
40248	Inox	4,5W	265	3,2W	332	35°	3000K	0,70	84,92
40249	Inox	4,5W	275	3,1W	359	35°	5000K	0,70	84,92

INSTALLAZIONE APPLICATION



Calpestabile/
Walk-Over

DISEGNI TECNICI TECHNICAL DRAWINGS

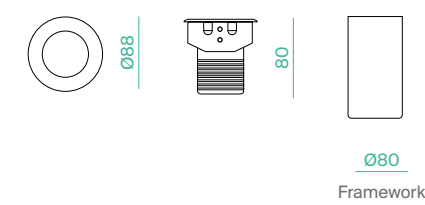

SKORPIO L



LED COB EDISON
CRI >80
PF 0.5

CODE	FINISHING	WATT	LUMEN	WATT LIGHT SOURCE	LUMEN LIGHT SOURCE	BEAM	KELVIN	KG	PRICE
40250	Inox	10W	600	9W	806	35°	3000K	1,42	138,00
40251	Inox	10W	615	9,1W	824	35°	5000K	1,42	138,00

INSTALLAZIONE APPLICATION



Calpestabile/
Walk-Over

DISEGNI TECNICI TECHNICAL DRAWINGS

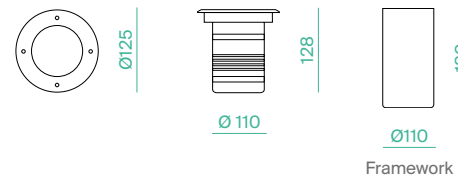

SKORPIO ACCESSORI ACCESSORIES



40015

40016

CODE	DESCRIPTION	PRICE
40015	Connettore IP67 1 via / IP67 connector_one exit	8,72
40016	Connettore IP67 2 vie / IP67 connector_two exits	14,29

GRUPPO EMERGENZA EMERGENCY UNIT

CODE	EFFICIENCY	WATT	KG	PRICE
12551	30% - 90MIN.	MAX 40W	0,10	63,36

DISEGNI TECNICI TECHNICAL DRAWINGS

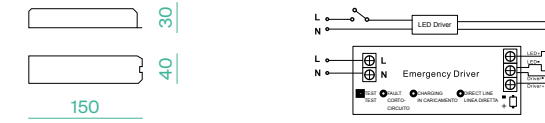

DRIVER



CODE	VOLTAGE	CURRENT	MODEL	SIZE	MODE	PRICE
42683	220-240 12-42V	650-1100mA	ONE4ALL	125x76x30mm	DALI, PUSH, 1-10V	58,33
42684	220-240 12-42V	250-600mA	ONE4ALL	125x76x30mm	DALI, PUSH, 1-10V	55,90
40314	110-277V 14-42V	400-1100mA	n/a	115x52x30mm	1-10V	50,56

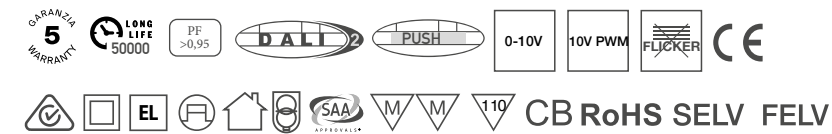

Listino Prezzi

Price List

CODE	PRICE	PAGE	CODE	PRICE	PAGE	CODE	PRICE	PAGE	CODE	PRICE	PAGE	CODE	PRICE	PAGE
11043	329,27	19-27-33	21305	7,13	120	22032	50,72	19-27-33	41113	96,00	15	41176	99,65	11
11044	219,51	19-27-33	21376	13,92	124	22033	65,05	19-27-33	41114	168,91	15	41177	132,45	11
11045	301,40	19-27-33	21377	14,68	125	22034	83,79	19-27-33	41115	241,82	15	41178	132,45	11
11371	82,40	132	21378	2,42	124-125	40015	8,72	144	41116	96,00	15	41179	93,58	11
11554	11,67	139	21379	2,04	124-125	40016	14,29	144	41117	168,91	15	41192	93,58	11
11620	20,89	49	21385	60,96	117	40248	84,92	143	41118	241,82	15	41193	96,00	15
11621	20,89	49	21386	4,54	117	40249	84,92	143	41119	48,61	13	41194	168,91	15
11654	157,97	127-131	21387	5,21	117	40250	138,00	144	41120	68,05	13	41195	241,82	15
11675	21,69	121	21388	60,21	116	40251	138,00	144	41121	120,30	13	41196	96,00	15
11906	33,05	121	21389	4,81	116	40314	50,56	145	41122	48,61	13	41197	168,91	15
11910	33,05	120	21440	16,18	126	40579	78,98	136	41123	68,05	13	41198	241,82	15
11911	29,96	118	21441	18,22	126	40580	103,30	136	41124	120,30	13	41199	48,61	13
11912	29,96	118	21442	8,87	126	40615	76,98	114	41125	120,30	14	41200	68,05	13
11913	29,96	118	21443	6,41	126	40617	76,98	114	41126	156,76	14	41201	120,30	13
11914	13,42	119	21444	0,98	126	40619	21,69	86	41127	241,82	14	41202	48,61	13
11915	13,42	119	21445	2,79	126	40624	36,57	86	41128	120,30	14	41203	68,05	13
11916	8,36	119	21446	1,06	126	40754	69,14	43	41129	156,76	14	41204	120,30	13
11917	8,36	119	21447	2,26	126	40755	69,14	43	41130	241,82	14	41205	120,30	14
11918	8,36	119	21472	22,12	123	40758	51,64	43	41131	13,37	19	41206	156,76	14
11919	3,09	119	21473	25,07	123	40759	51,64	43	41132	12,76	19-27	41207	241,82	14
11920	3,51	119	21474	7,03	123	40760	61,98	100	41132/A	12,76	19-27	41208	120,30	14
11921	3,51	119	21475	9,70	123	40761	61,98	100	41133/A	12,76	19-27	41209	156,76	14
11922	16,78	119	21476	0,98	123	40762	32,96	103	41134	4,85	19	41210	241,82	14
11923	29,96	118	21477	2,55	123	40763	32,96	103	41135	4,85	19	41211	108,15	16
11924	8,36	119	21494	19,49	124	41063	28,98	81	41136	53,47	18	41212	108,15	16
11925	14,25	122	21495	22,95	124	41064	28,98	81	41137	53,47	18	41213	99,65	11
11926	1,50	122	21496	2,49	124-125	41065	31,17	81	41138	53,47	18	41214	99,65	11
11927	1,50	122	21497	3,39	124-125	41066	31,17	81	41139	53,47	18	41215	132,45	11
12551	63,36	145	21498	29,42	125	41094	200,50	46	41140	53,47	18	41216	132,45	11
12556	18,11	81-85	21499	33,04	125	41095	200,50	46	41141	53,47	18	41217	153,61	19-27-33
12557	12,03	81-85	21500	5,50	125	41096	200,50	46	41142	8,51	19	41218	169,66	19-27-33
13570	36,77	121	21721	35,69	72	41097	200,50	46	41143	8,51	19	41219	214,37	19-27-33
13571	45,44	121	21722	35,69	72	41098	200,50	46	41144	216,30	18	41222	8,38	19
13572	53,29	121	21723	48,15	73	41099	200,50	46	41145	216,30	18	41223	8,38	19
21048	10,84	124	21724	48,15	73	41100	200,50	46	41146	6,68	18	41240	20,05	19
21049	11,82	125	21725	48,15	73	41101	200,50	46	41164	77,78	140	41241	20,05	19
21051	5,95	124-125	21726	48,15	73	41102	200,50	46	41165	125,17	140	41257	59,54	19
21052	7,91	124-125	21727	48,15	73	41103	200,50	46	41166	75,33	139	41258	59,54	19
21053	0,84	124-125	21728	48,15	73	41104	200,50	46	41167	72,91	138	41259	59,54	19
21054	0,57	124-125	22015	34,45	19-27-33	41105	200,50	46	41168	103,30	138	41260	59,54	19
21301	5,95	116-124 125	22016	61,74	19-27-33	41109	108,15	18	41169	168,91	138	41281	13,70	72
21303	7,13	120	22017	132,30	19-27-33	41110	108,15	18	41173	108,15	16	41282	13,70	72
21304	9,24	120	22025	65,05	19-27-33	41111	93,58	11	41174	108,15	16	41283	15,71	73
			22031	39,69	19-27-33	41112	93,58	11	41175	99,65	11	41284	15,71	73

CODE	PRICE	PAGE	CODE	PRICE	PAGE	CODE	PRICE	PAGE	CODE	PRICE	PAGE	CODE	PRICE	PAGE
41285	20,19	75	41690	89,51	77	41750	49,75	27	41809	98,57	38	41858	102,00	35
41286	20,19	75	41691	89,51	77	41751	49,75	27	41810	98,57	38	41859	102,00	35
41287	16,12	72	41692	89,51	77	41752	49,75	27	41811	66,56	34	41860	102,00	35
41288	19,98	73	41693	89,51	77	41753	55,16	27	41812	66,56	34	41861	102,00	35
41289	30,39	75	41694	89,51	77	41754	55,16	27	41813	66,56	34	41862	118,00	37
41290	38,63	133	41695	89,51	77	41755	55,16	27	41814	66,56	34	41863	118,00	37
41291	45,84	133	41696	89,51	77	41756	55,16	27	41815	98,57	38	41864	118,00	37
41292	38,63	133	41697	89,51	77	41757	4,33	27	41816	98,57	38	41865	118,00	37
41293	45,84	133	41705	92,54	103	41758	4,33	27	41817	98,57	38	41866	132,00	39
41444	158,22	110	41706	92,54	103	41759	7,57	27-33	41818	66,56	34	41867	132,00	39
41445	158,22	110	41707	113,50	97	41760	7,57	27-33	41819	66,56	34	41868	132,00	39
41446	180,72	110	41708	113,50	97	41761	7,91	27	41820	66,56	34	41869	66,56	98
41447	180,72	110	41713	87,60	26	41762	7,91	27	41821	66,56	34	41870	66,56	98
41448	169,25	110	41714	87,60	26	41763	12,61	27	41822	98,57	38	41871	66,56	98
41449	169,25	110	41715	175,20	26	41764	6,30	27-33	41823	98,57	38	41872	66,56	98
41450	191,75	110	41716	175,20	26	41765	18,91	27	41824	98,57	38	41873	66,56	98
41451	191,75	110	41717	47,59	21	41766	18,91	27	41825	102,00	35	41874	66,56	98
41452	168,44	111	41718	47,59	21	41770	99,50	12	41826	102,00	35	41875	66,56	98
41453	168,44	111	41719	83,28	21	41771	99,50	12	41827	102,00	35	41876	66,56	98
41454	190,94	111	41720	83,28	21	41772	139,51	11	41828	102,00	35	41877	66,56	98
41455	190,94	111	41721	147,08	21	41773	139,51	11	41829	118,00	37	41878	66,56	98
41456	191,88	111	41722	147,08	21	41774	93,01	16	41830	118,00	37	41879	66,56	98
41457	191,88	111	41723	67,05	23	41775	93,01	16	41831	118,00	37	41880	66,56	98
41458	214,38	111	41724	67,05	23	41776	89,76	17	41832	118,00	37	41881	66,56	98
41459	214,38	111	41725	117,88	23	41777	89,76	17	41833	132,00	39	41882	66,56	98
41666	79,60	36	41726	117,88	23	41778	88,68	12	41834	132,00	39	41883	66,56	98
41667	79,60	36	41727	171,96	23	41779	88,68	12	41835	132,00	39	41884	66,56	98
41668	79,60	36	41728	171,96	23	41780	26,22	27	41836	102,00	35	41885	419,99	95
41669	79,60	36	41729	112,48	22	41781	26,22	27	41837	102,00	35	41886	567,68	95
41670	79,60	36	41730	112,48	22	41782	26,22	19	41838	102,00	35	41887	419,99	95
41671	79,60	36	41731	171,96	22	41783	26,22	19	41839	102,00	35	41888	567,68	95
41672	79,60	36	41732	171,96	22	41784	166,55	27	41840	118,00	37	41889	375,90	97
41673	79,60	36	41733	84,36	20	41785	222,79	27	41841	118,00	37	41890	529,70	97
41674	79,60	36	41734	84,36	20	41786	274,70	27	41842	118,00	37	41891	375,90	97
41675	79,60	36	41735	88,27	20	41788	166,55	27	41843	118,00	37	41892	529,70	97
41676	79,60	36	41736	88,27	20	41789	222,79	27	41844	132,00	39	41905	98,57	38
41677	79,60	36	41737	102,03	24	41790	274,70	27	41845	132,00	39	41906	98,57	38
41678	79,60	36	41738	102,03	24	41797	66,56	34	41846	132,00	39	41907	98,57	38
41679	79,60	36	41739	99,50	24	41798	66,56	34	41847	102,00	35	41908	98,57	38
41680	79,60													

CODE	PRICE	PAGE	CODE	PRICE	PAGE	CODE	PRICE	PAGE	CODE	PRICE	PAGE	CODE	PRICE	PAGE
41919	93,73	101	42666	487,53	8	42728	5,84	9	42794	114,45	131	42845	47,90	33
41920	93,73	101	42667	487,53	8	42730	48,13	10	42795	114,45	131	42846	47,90	33
41921	121,54	101	42668	487,53	8	42731	48,13	10	42796	171,15	131	42847	47,90	33
41922	121,54	101	42669	487,53	8	42732	26,74	10	42799	171,15	131	42848	47,90	33
41923	93,01	44	42672	7,29	9	42735	78,98	104	42800	103,95	130	42849	52,74	33
41924	93,01	44	42673	13,13	9	42736	78,98	104	42801	103,95	130	42850	52,74	33
41925	89,76	45	42674	13,13	9	42737	18,84	82	42802	103,95	130	42851	52,74	33
41926	89,76	45	42675	18,22	9	42738	18,84	82	42803	103,95	130	42852	52,74	33
41927	108,15	44	42676	18,22	9	42739	18,84	83	42804	103,95	130	42853	11,85	33
41928	108,15	44	42677	16,04	9	42740	18,84	83	42805	103,95	130	42854	12,76	33
42044	197,50	6	42678	16,04	9	42741	18,84	84	42806	103,95	130	42855	12,76	33
42045	197,50	6	42679	5,84	9	42742	18,84	84	42807	103,95	130	42856	12,76	33
42046	197,50	6	42680	5,84	9	42743	11,30	82-83-84	42808	186,02	19	42857	12,76	33
42047	197,50	6	42681	9,96	9	42744	21,26	85	42809	203,32	19	42858	4,33	33
42048	266,00	6	42682	17,25	9	42745	21,26	85	42810	246,58	19	42859	4,33	33
42049	266,00	6	42683	58,33	145	42747	33,90	94	42811	186,02	19	42862	7,91	33
42050	266,00	6	42684	55,90	145	42748	33,90	94	42812	203,32	19	42863	7,91	33
42051	266,00	6	42685	17,25	9	42749	24,18	94	42813	246,58	19	42864	26,22	33
42052	333,00	6	42686	37,99	79	42750	24,18	94	42814	171,96	27	42865	26,22	33
42053	333,00	6	42687	37,99	79	42751	91,13	105	42815	229,28	27	43126	81,12	134
42054	333,00	6	42688	37,99	79	42752	91,13	105	42816	280,11	27	43127	81,12	134
42055	333,00	6	42689	37,99	79	42753	103,30	127	42817	171,96	27	43128	104,82	134
42056	19,20	7	42690	37,99	79	42754	103,30	127	42818	229,28	27	43129	104,82	134
42057	19,20	7	42691	37,99	79	42755	103,30	127	42819	280,11	27	43130	81,12	134
42058	11,40	7	42692	37,99	79	42756	103,30	127	42820	103,30	127	43131	81,12	134
42059	2,40	7	42693	37,99	79	42757	103,30	127	42821	71,07	32	43132	104,82	134
42060	18,00	7	42694	47,87	80	42758	103,30	127	42822	71,07	32	43133	104,82	134
42061	18,00	7	42695	47,87	80	42759	103,30	127	42823	140,08	32	43134	92,06	135
42062	7,90	7	42696	47,87	80	42760	103,30	127	42824	140,08	32	43135	92,06	135
42064	61,00	7	42697	47,87	80	42761	103,30	127	42825	73,13	30	43136	123,04	135
42065	61,00	7	42698	47,87	80	42762	120,30	128	42826	73,13	30	43137	123,04	135
42531	142,19	112	42699	47,87	80	42763	131,24	129	42827	132,87	30	43138	92,06	135
42532	142,19	112	42700	47,87	80	42776	291,63	8	42828	132,87	30	43139	92,06	135
42619	62,22	115	42701	47,87	80	42777	291,63	8	42829	112,27	29	43140	123,04	135
42620	66,11	115	42703	7,17	79	42778	291,63	8	42830	112,27	29	43143	123,04	135
42621	54,45	115	42704	16,88	80	42779	291,63	8	42831	135,96	29	43144	81,12	137
42622	58,33	115	42705	11,67	80	42780	437,47	8	42832	135,96	29	43145	81,12	137
42654	240,60	8	42706	190,45	112	42781	437,47	8	42833	174,07	29	43146	104,82	137
42655	240,60	8	42707	190,45	112	42782	437,47	8	42834	174,07	29	43147	104,82	137
42656	240,60	8	42708	221,55	112	42783	437,47	8	42835	84,36	28	43148	81,12	137
42657	240,60	8	42709	221,55	112	42784	181,06	19	42836	84,36	28	43149	81,12	137
42658	331,74	8	42720	120,30	128	42785	198,08	19	42837	88,27	28	43150	104,82	137
42659	331,74	8	42721	120,30	128	42786	241,82	19	42838	88,27	28	43151	104,82	137
42660	331,74	8	42722	120,30	128	42787	181,06	19	42839	99,50	31	43160	96,00	96
42661	331,74	8	42723	120,30	128	42788	198,08	19	42840	99,50	31	43161	96,00	96
42662	390,32	8	42724	131,24	129	42789	241,82	19	42841	89,76	31	43162	108,15	96
42663	390,32	8	42725	131,24	129	42790	101,23	142	42842	89,76	31	43163	108,15	96
42664	390,32	8	42726	131,24	129	42791	10,94	142	42843	47,90	33	43164	71,07	106
42665	390,32	8	42727	131,24	129	42792	7,80	142	42844	47,90	33	43165	71,07	106

CODE	PRICE	PAGE	CODE	PRICE	PAGE	CODE	PRICE	PAGE	CODE	PRICE	PAGE	CODE	PRICE	PAGE	CODE	PRICE	PAGE	CODE	PRICE	PAGE	CODE	PRICE	PAGE
43166	29,66	106	53448 B/GU10	48,97	91	60061	22,41	49	71585	16,38	62	71712	24,13	66									
43167	29,66	106	53449/ GU10	74,76	91	60062	22,41	49	71586	16,38	62	71723	30,59	67									
43168	87,50	141	53449 B/GU10	74,76	91	60064	22,41	49	71588	16,38	62	71724	30,59	67									
43169	87,50	141	53450/ GU10	101,93	92	60065	22,41	49	71589	16,38	62	71726	30,59	67									
43170	102,49	113	53450 B/GU10	101,93	92	60067	31,91	49	71591	16,38	62	71727	30,59	67									
43171	102,49	113	53454/ GU10	64,24	92	60068	31,91	49	71592	16,38	62	71729	30,59	64									
43172	141,93	113	53454 B/GU10	64,24	92	60070	31,91	49	71594	24,13	63	71730	30,59	64									
43173	141,93	113	53455/ GU10	102,78	93	60071	31,91	49	71595	24,13	63	71732	30,59	64									
43174	119,38	114	53455 B/GU10	102,78	93	60073	31,91	49	71597	24,13	63	71733	30,59	64									
43175	119,38	114	53456/ GU10	136,67	93	60074	31,91	49	71598	24,13	63	71735	30,59	64									
51011	27,25	78	53456 B/GU10	136,67	93	60076	31,91	49	71600	12,52	67	71736	30,59	64									
51012	29,85	78	53903/ 230	168,16	108	60077	31,91	49	71601	12,52	67	71738	30,59	64									
51013	47,24	78	56900/ 230	139,59	107	60079	37,95	49	71603	12,52	67	71739	30,59	64									
51014	57,62	78	56901/ 230	189,68	107	60080	37,95	49	71604	12,52	67	71741	41,10	65									
51015	60,21	78	56902/ 230	215,93	108	60084	22,41	49	71606	29,87	68-74	71742	41,10	65									
51016	13,49	78	56904/ 230	209,96	109	60085	22,41	49	71607	29,87	68-74	71744	41,10	65									
51017	15,06	78	56905/ 230	268,42	109	60086	4,32	49	71608	29,87	68-74	71745	41,10	65									
51018	16,61	78	57900/ 230	139,59	107	60087	4,32	49	71609	29,87	68-74	71747	41,49	68									
51019	16,61	78	57901/ 230	189,68	107	60088	13,88	49	71610	30,90	68-74	71748	41,49	68									
51020	16,61	78	57902/ 230	215,93	108	60089	13,88	49	71611	30,90	68-74	71749	41,49	68									
51021	21,28	78	57903/ 230	168,16	108	60100	77,21	47	71612	30,90	68-74	71750	41,49	68									
51022	22,85	78	57904/ 230	209,96	109	60101	77,21	47	71613	30,90	68-74	71751	42,18	68									
51023	33,23	78	57905/ 230	268,42	109	60102	112,75	47	71614	31,93	68-74	71752	42,18	68									
51024	33,23	78	57900/ 230	139,59	107	60103	112,75	47	71615	31,93	68-74	71753	42,18	68									
51025	39,97	78	57901/ 230	189,68	107	60104	2,13	50	71616	31,93	68-74	71754	42,18	68									
51026	43,31	78	57902/ 230	215,93	108	60105	2,13	50	71617	31,93	68-74	71755	83,43	69									
51027	54,02	78	57903/ 230	168,16	108	60106	2,74	50	71618	46,61	68-74	71756	83,43	69									
51028	59,86	78	57904/ 230	209,96	109	60107	2,74	50	71619	46,61	68-74	71757	83,43	69									
52582 /B	10,69	49	57905/ 230	268,42	109	60108	2,74	50	71620	46,61	68-74	71758	83,43	69									
52582 /N	10,69	49	60037	35,62	47	60109	2,74	50	71621	46,61	68-74	71759	86,01	69									
53421/ GU10	41,30	88	60038	35,62	47	60110	2,74	50	71622	52,53	68-74	71760	86,01	69									
53423/ GU10	67,71	88	60040	65,63	47	60111	2,74	50	71623	52,53	68-74	71761	86,01	69									
53425/ GU10	94,12	89	60041	65,63	47	60112	3,36	50	71624	52,53	68-74	71762	86,01	69									
53426/ GU10	41,30	88	60043	95,84	47	60113	3,36	50	71625	52,53	68-74	71763	71,07	63-74									
53427/ GU																							

CODE	PRICE	PAGE	CODE	PRICE	PAGE	CODE	PRICE	PAGE	CODE	PRICE	PAGE	CODE	PRICE	PAGE
71798	38,32	56	71847	55,41	56	71896	79,88	56	71957	29,96	76	72045	26,00	52
71799	38,32	56	71848	55,41	56	71897	79,88	56	71958	50,08	76	72046	26,00	52
71800	38,32	56	71849	55,41	56	71898	89,76	58	71959	50,08	76	72047	24,00	52
71801	38,32	56	71850	71,22	58	71899	89,76	58	71960	68,44	76	72048	24,00	52
71802	49,34	58	71851	71,22	58	71900	89,76	58	71961	68,44	76	72049	26,00	52
71803	49,34	58	71852	71,22	58	71901	89,76	58	71962	38,96	102	72050	26,00	52
71804	49,34	58	71853	71,22	58	71902	89,76	58	71963	38,96	102	72051	26,50	53
71805	49,34	58	71854	71,22	58	71903	89,76	58	71964	39,78	102	72052	26,50	53
71806	49,34	58	71855	71,22	58	71904	89,76	58	71965	39,78	102	72053	28,50	53
71807	49,34	58	71856	71,22	58	71905	89,76	58	71974	67,20	40	72054	28,50	53
71808	49,34	58	71857	71,22	58	71906	106,86	60	71975	67,20	40	72055	26,50	53
71809	49,34	58	71858	88,84	60	71907	106,86	60	71976	67,20	40	72056	26,50	53
71810	63,60	60	71859	88,84	60	71908	106,86	60	71977	67,20	40	72057	28,50	53
71811	63,60	60	71860	88,84	60	71909	106,86	60	71978	67,20	40	72058	28,50	53
71812	63,60	60	71861	88,84	60	71910	106,86	60	71979	67,20	40	72059	26,50	53
71813	63,60	60	71862	88,84	60	71911	106,86	60	71980	67,20	40	72060	26,50	53
71814	63,60	60	71863	88,84	60	71912	106,86	60	71981	67,20	40	72061	28,50	53
71815	63,60	60	71864	88,84	60	71913	106,86	60	71982	67,20	40	72062	28,50	53
71816	63,60	60	71865	88,84	60	71914	84,96	57	71983	67,20	40	72063	26,50	53
71817	63,60	60	71866	60,50	57	71915	84,96	57	71984	67,20	40	72064	26,50	53
71818	43,40	57	71867	60,50	57	71916	84,96	57	71985	67,20	40	72065	28,50	53
71819	43,40	57	71868	60,50	57	71917	84,96	57	71986	67,20	40	72066	28,50	53
71820	43,40	57	71869	60,50	57	71918	84,96	57	71987	67,20	40	72067	30,00	54
71821	43,40	57	71870	60,50	57	71919	84,96	57	71988	67,20	40	72068	30,00	54
71822	43,40	57	71871	60,50	57	71920	84,96	57	71989	67,20	40	72069	32,00	54
71823	43,40	57	71872	60,50	57	71921	84,96	57	71998	82,88	41	72070	32,00	54
71824	43,40	57	71873	60,50	57	71922	95,60	59	71999	82,88	41	72071	30,00	54
71825	43,40	57	71874	77,06	59	71923	95,60	59	72000	82,88	41	72072	30,00	54
71826	55,18	59	71875	77,06	59	71924	95,60	59	72001	82,88	41	72073	32,00	54
71827	55,18	59	71876	77,06	59	71925	95,60	59	72002	82,88	41	72074	32,00	54
71828	55,18	59	71877	77,06	59	71926	95,60	59	72003	82,88	41	72075	30,00	54
71829	55,18	59	71878	77,06	59	71927	95,60	59	72004	82,88	41	72076	30,00	54
71830	55,18	59	71879	77,06	59	71928	95,60	59	72005	82,88	41	72077	32,00	54
71831	55,18	59	71880	77,06	59	71929	95,60	59	72006	82,88	41	72078	32,00	54
71832	55,18	59	71881	77,06	59	71930	113,27	61	72007	82,88	41	72079	30,00	54
71833	55,18	59	71882	95,24	61	71931	113,27	61	72008	82,88	41	72080	30,00	54
71834	70,25	61	71883	95,24	61	71932	113,27	61	72009	82,88	41	72081	32,00	54
71835	70,25	61	71884	95,24	61	71933	113,27	61	72010	82,88	41	72082	32,00	54
71836	70,25	61	71885	95,24	61	71934	113,27	61	72011	82,88	41	72083	32,00	71
71837	70,25	61	71886	95,24	61	71935	113,27	61	72012	82,88	41	72084	32,00	71
71838	70,25	61	71887	95,24	61	71936	113,27	61	72013	82,88	41			
71839	70,25	61	71888	95,24	61	71937	113,27	61	72037	7,00	52			
71840	70,25	61	71889	95,24	61	71948	28,50	76	72038	7,00	53			
71841	70,25	61	71890	79,88	56	71949	28,50	76	72039	7,00	54			
71842	55,41	56	71891	79,88	56	71950	49,24	76	72040	23,60	52			
71843	55,41	56	71892	79,88	56	71951	49,24	76	72041	16,00	53			
71844	55,41	56	71893	79,88	56	71952	67,96	76	72042	28,80	54			
71845	55,41	56	71894	79,88	56	71953	67,96	76	72043	24,00	52			
71846	55,41	56	71895	79,88	56	71956	29,96	76	72044	24,00	52			

Indice alfabetico

Alphabetical index

A	97 A+B SOFFITTO	I	45 INVISIBILE	44-45 SOSPENSIONI TRACK
	95 A+B SOSPENSIONE		130 IOTA	46 STREAMLIGHT TRACK
	104-105 ALTAIR			10 STREAMLIGHT INCASSO
	86 AQUA_EVO	K	11 KLIK_KLAK	8 STREAMLIGHT SYSTEM
B	78 BELLATRIX		101 KLIK_KLAK PUNIFORME SOFFITTO	114 SU&GIÙ
	114 BLOC_EVO		20 KLIK KLAK MINI	42 SUN_111 TRACK
	40 BOMBO		28 KLIK KLAK MICRO	99 SUN_111 SOFFITTO/PARETE
	106 BOX	L	72 LIGHT_35	T
C	141 COMBI EVO		73 LIGHT_50	134 TITANO_EVO
	107-109 CONTAINER		75 LIGHT_111	111 TORCIA_O
	103 CYL SOFFITTO		6 LINEAR SYSTEM	110 TORCIA_V
	97 CYL SOSP		120 LINE DEEP	47-48 TRACKS
D	142 DARDO		121 LINE	127 TWIGGY_LESS
	62-63 DEEP_EVO		118 LINE_EVO	U
	56-61 DEEP_EVO EXTR.		122 LINE_MINI	43 UNICO TRACK
	64-65 DEEP_EVO GRANDE		76 LUMIS_Q	100 UNICO DICRO SOFFITTO/PARETE
	66 DEEP_EVO_Q		102 LUMIS_Q SOFFITTO	W
	67 DEEP_EVO_Q GRANDE		76 LUMIS_T	116 WALL
	67 DEEP_EVO STD		102 LUMIS_T SOFFITTO	94 WIZARD
	70 DEEP_EVO GU10	M	82 MINI	Z
	71 DEEP_EVO AR111 GU10		112 MINIMA	131 ZEN
	128 DIOGENE		68-69 MODULI LED DEEP_EVO	85 ZEUS
	52 DOT		74 MODULI LED+ADATTATORE FOR LIGHT_50	
	123 DOUBLE		138 MOONLIGHT	
	145 DRIVER E ACCESSORI	O	81 OCCHIO	
	115 DUMBO		117 ONDA	
E	51 EMERGENZA TRACK	P	124 PR1	
	113 ESSENTIAL		124 PR1_DEEP	
F	140 FOS		125 PR2	
	88 FRAME		125 PR2_DEEP	
	89 FRAME 111		126 PR3_EVO	
	91 FRAMELESS		78-79 PUNTO	
	92 FRAMELESS 111	S	143 SKORPIO	
	34 FULGOR TRACK		96 SHANGHAI	
	77 FULGOR_IN		133 SLICE	
	98 FULGOR SOFFITTO/PARETE			

Logica è un marchio di Marino Cristal S.p.A.

Marino Cristal S.p.A.

Via Guardia del Consiglio, 31
47899 Serravalle
Rep. di San Marino

Tel. (+378) 0549 901188
Fax (+378) 0549 900612

www.logicailuminazione.com
info@logicailuminazione.com

Progetto grafico
Studio JAM

Stampa
Pazzini Stampatore Editore